

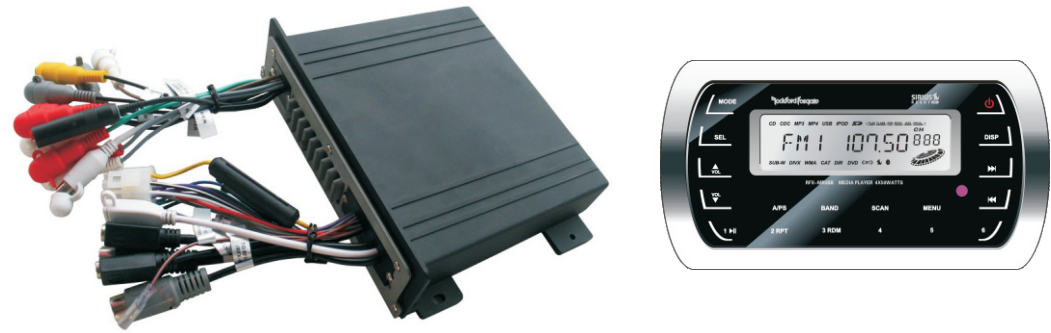

## OPERATION MANUAL

MODEL: RFX4000



- ◆ DIGITAL AUDIO PLAYER
- ◆ SIRIUS READY
- ◆ AM/FM STEREO RADIO
- ◆ USB/SD MUSIC PLAY
- ◆ BLUETOOTH STRAM

# CONTENTS

---

CONTENTS.....	1
CONTROL PANEL ILLUSTRATION.....	2
REMOTE CONTROL FUNCTION.....	3
WIRE DIAGRAM.....	4
INSTALLATION.....	5
BASIC OPERATION.....	6
SIRIUS OPERATION.....	7-10
RADIO OPERATION/AUX.....	11
USB/SD/CDC OPERATION.....	12
BLUETOOTH OPERATION.....	13
SPECIFICATION.....	14
TROUBLESHOOTING.....	15

## TROUBLESHOOTING

### Can not read some USB devices

The unit is not 100% compatible with all USB devices or the USB device has special format. Try to format the USB device in FAT 16/32 standard.

### Can not play certain songs with specific formats that are downloaded from websites

Example: Tunes which is in DRM(digital right management) format is not supported by the current unit.

### Unit takes about 60 seconds to recognize some USB device

It is normal. The unit sometimes takes longer time to read all the files inside the USB device.

### LCD Can Not display the MP3 song name correctly

The songs are in foreign language or not in ID3 Tag format.

### Power does not turn on (no sound)

Check the wire.

Check the unit fuse. Replace new fuse if blown. If it happens again, consult the dealer.

### No sound out put when operating the unit with amplifiers or power antenna is attached

Power antenna lead is shorted to ground or excessive current is required for amplifiers or power antenna.

### Button is not responsive or the LCD display is wrong.

The connection pins for the front panel may be dirty. Use a soft cloth to clean its surface.

If it does not fix the problem, consult your dealer.

The unit picks up the engine noise. Check the ground wire.

### After turn the power on, the unit powers off immediately

The battery may be too low (The unit operating voltage is 11V to 16V). If the unit still cannot turn on, consult your dealer.

### RFX-MR7 and RFX-MR5BB have button malfunction with water splash.

The touch panel is very sensitive. Please use dry towel or paper to wipe the water from the control panel.

### RFX-MR7 buttons fail to response.

Check if you locked the button. Press and hold "Mute" and "Volume -" for 3 second to unlock.

### RFX-MR5BB buttons fail to response

Check if you locked the buttons. Press and hold "DISP" and "SEL" buttons to unlock.

## WARRANTY INFORMATION:

Should this product require service, you may obtain specific information by contacting the dealer from whom this product was purchased.

For any service related questions, please call our technical service team.

Technical Support Phone Number: 574-293-1521

## CONTROL PANEL ILLUSTRATION

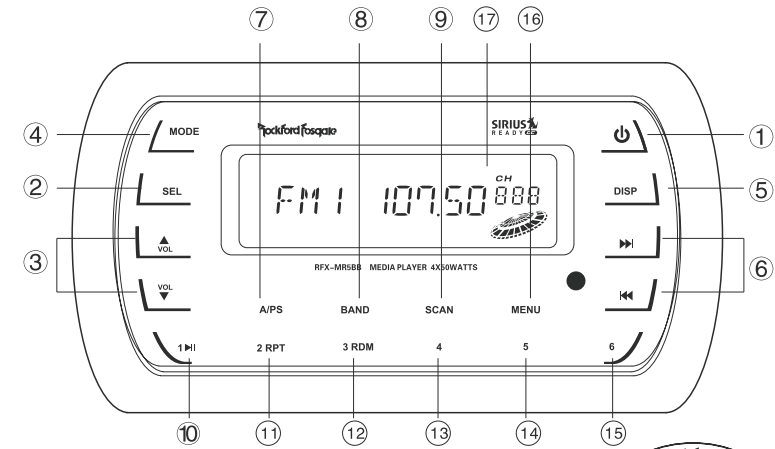

(OPTION)

- ①. POWER ON/OFF
- ②. FUNCTION SELECT BUTTON
- ③. VOLUME UP/DOWN
- ④. MODE BUTTON
- ⑤. DISPLAY BUTTON
- ⑥. AUTOMATIC OR MANUAL TUNING  
(FREQ UP ►► OR FREQ DOWN ◄◄)
- ⑦. AUTO STORE AND PRESET SCAN/MENU(A/PS)  
/SELECT TRACK/CHANNEL SWITCH
- ⑧. BAND/CDC DISC UP/ -10 TRACKS
- ⑨. AUTOMATIC TUNING CONTROL(SCAN)  
/CDC DISC DOWN/ +10 TRACKS
- ⑩. PRESET 1, PLAY/PAUSE
- ⑪. PRESET 2, REPEAT PLAY
- ⑫. PRESET 3, RANDOM PLAY
- ⑬. PRESET 4/LEFT
- ⑭. PRESET 5/DOWN(ENTER)
- ⑮. PRESET 6/RIGHT
- ⑯. MENU/DIMMER SETTING BUTTON/UP
- ⑰. LCD DISPLAY
- ⑱. MUTE

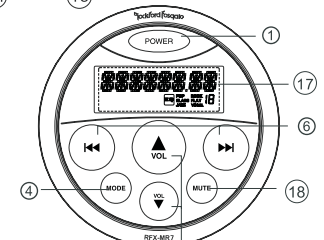

(RFX-MR7  
OPTION)

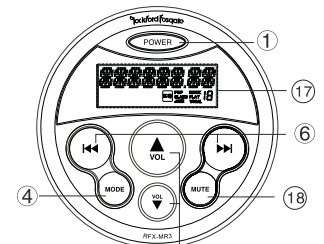

(RFX-MR3  
OPTION)

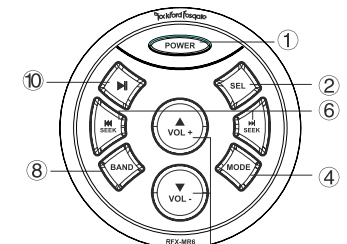

(RFX-MR6  
OPTION)

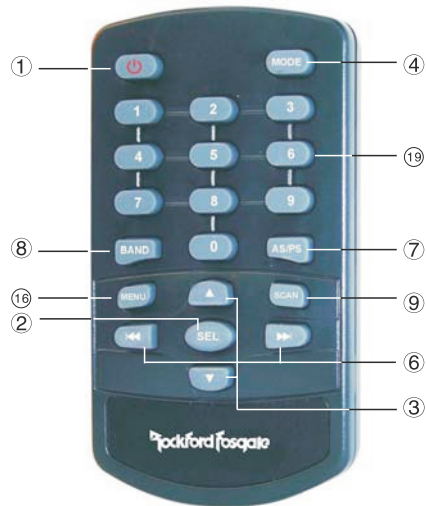

(OPTION)

- ①. POWER ON/OFF
- ②. FUNCTION SELECT BUTTON
- ③. VOLUME UP/DOWN
- ④. MODE BUTTON
- ⑥. AUTOMATIC TUNING  
(FREQ UP ◀◀ OR FREQ DOWN ▶▶ )
- ⑦. PRESET SCAN/(A/PS)
- ⑧. BAND/CDC DISC UP
- ⑨. AUTOMATIC TUNING CONTROL  
/CDC DISC DOWN
- ⑬. MENU/DIMMER SETTING BUTTON
- ⑱. NUM0~NUM9

## TUNER(FM)

Frequency Range.....	87.5-107.9 MHz
Channel Step.....	200KHz
Sensitivity .....	8dB
Stereo Separation.....	30dB
Signal to Noise Ratio.....	60dB

## TUNER(AM)

Frequency Range.....	530-1710 KHz
Usable Sensitivity.....	32 dBuV
Channel Step.....	10KHz
Signal to Noise Ratio.....	50dB

## LINE-OUT

Output.....	3 Volt ( max )
Impedance.....	33 Ohm

## GENERAL

Power Supply.....	13.8V DC (10-15.6V allowable)
Speaker Impedance.....	4 or 8 ohm
Output Power.....	50W x 4CH
Fuse.....	10A

Note: Specifications and the design are subject to possible modification without notice due to improvement.

# BLUETOOTH OPERATION

## (BLUETOOTH DONGLE)



**MODEL: RFX4000BT**

### Installation Note for Bluetooth Dongle

To get better signal, the Bluetooth Dongle needs to be installed near the surface and must avoid a metal surface.

If the Dongle is installed under a metal surface or deep inside, it may have a poor Bluetooth signal.

### Bluetooth mode select

Press the MODE(4) button and select the Bluetooth mode .  
Make sure the Bluetooth Dongle is connected to the appropriate port on the unit.

### Pairing with a Bluetooth device

The unit is ready to pair when the BT mode is selected. To pair your device to the unit, make sure you are close enough to the unit.

1. Open the Bluetooth setting on your device,
2. Choose "RFX4000" from the list of the available Bluetooth link,
3. Enter "0000" as the Bluetooth password.

### Play the Bluetooth music

When you succeed in pairing the Bluetooth device, you can play the Bluetooth music on your device.

- a. Press the previous/next key to change the track.
- b. Press the play/pause key to start or pause the audio.
- c. Press and hold A/PS key to disconnect the current Bluetooth device from the unit, but this will not erase the pairing from unit memory.
- d. Press and hold BAND keys to erase all Bluetooth pairings stored in the unit memory.

# WIRE DIAGRAM

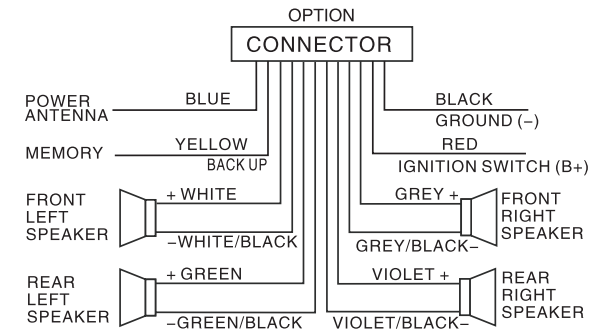
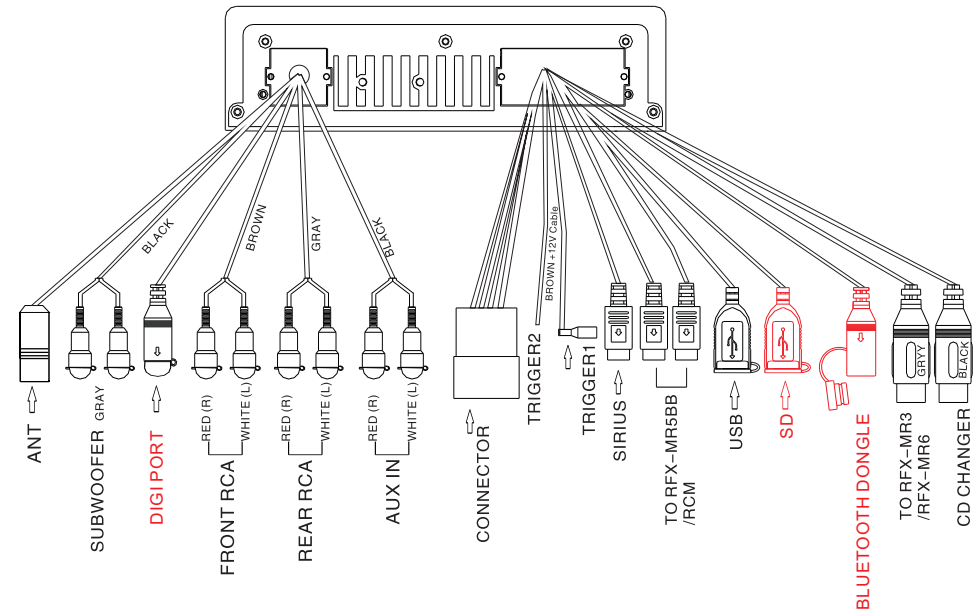

### Fuse replacement

If the fuse blows, check the power connection and replace the fuse. If the fuse blows again after the replacement, there may be an internal malfunction. In this case, consult your nearest repairing center.



### Warning:

Only replace fuse with the same type and rating. Use of a different type or rating may cause serious damage.

Be sure your wire remote (RFX-MR3/RFX-MR6) is installed correctly, wrong connection will cause serious damage to the wire remote.

## 1. Precautions

Choose the mounting location carefully so that the unit will not interfere with the normal driving functions of the boat.

Avoid installing the unit where it would be subject to high temperature, such as from direct sunlight or hot air, or where it would be subject to dust, dirt or excessive vibration.

Use only the supplied mounting hardware for a safe and secure installation.

## 2. Mounting illustration

### Correct mounting positions

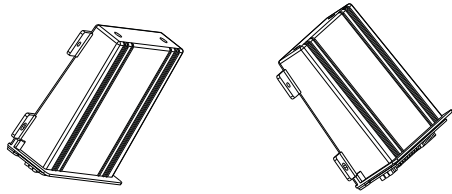

Better: 45 facing upward

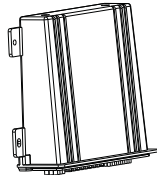

Best: 90 facing upward

### Incorrect mounting positions

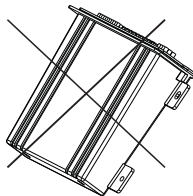

Do not mount black box in either of the following positions, this will allow water to intrude and will result in damage to the unit.

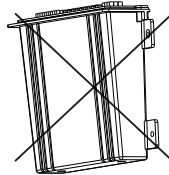

## 3. Installation Note

Please find enclosed nylon wire tie-downs(wire clamps)for added support. use the wire clamps to hold down the harness, preventing water from running along the wires and into the unit.

## USB PORT

When a USB device with audio files is plugged, the unit will play the audio files automatically. You may use SCAN as "10+" button and BAND as "10-" button for fast search during the USB operation.

The marine unit can support playing the music in USB by inputting the song sequence number directly: when the unit is playing songs, press AS/PS button on the front panel, it will display "SCH 0000" on the LCD, the four digits indicates the sequence number that you want to listen to. You can use preset key 1,2,3,4, to set the four digits by pressing them repeatedly and press SEL to confirm input, the unit will start playing the new song automatically.

## SD PORT

When a SD card with a card-reader is plugged, the unit will turn to the SD mode and play the audio files that in the SD card automatically.



The SD mode has the same function as the USB mode.

### IMPORTANT NOTE:

Because of the great variety of products with USB port and sometimes quite manufacturer-specific functions we can neither guarantee that all devices will be recognized nor that all operating options that are possible in theory will actually work.

Some USB/SD devices may take more than 45 seconds to initiate after plugging in.

## CDC Operation

- (1) Press  to power on.
- (2) Connect the CDC to your unit, then press "MODE" to CDC mode.
- (3) The LCD will display "disc style" " item number" "playing time".
- (4) Press "  " to pause the playing.
- (5) Press PRESET 2 (11) to enter REPEAT playing mode.
- (6) Press PRESET 3 (12) to enter RANDOM playing mode.
- (7) Follow the function key instruction to do the operation.
- (8) You may press SCAN as "next- disc" button and BAND as "pre-disc" button for change disc operation.

## Notes for CD

- (1) Keep the disk clean and undamaged, do not stick things on the disc.
- (2) Do not play the damaged or transformative disc, keep the disc correctly .
- (3) Do not keep the disc under sunshine or in high temperature environment .
- (4) Put the disc into its box after using.
- (5) Finger mark or besmirch will effect the disc playing quality, it can't be cleaned by soft cloth. If it is necessary , diluted natural solvent can be used to help clean the disc. Record cleaner or antistatic solvent can't be used to clean the disc.

### Radio Operation

Listening to the radio

Press the MODE (4) button and select the radio mode, the frequency appears in the display.

Press the BAND (8) button and select the radio band FM1~FM2~FM3~AM1~AM2.

Tuning

There are 3 types of tuning mode available: SEEK tuning, MANUAL tuning and Preset stations.

Auto Seek a Station

Press the BAND (8) button and select the desired band (FM or AM).

Press ►► or ◀◀ to start to seek a station.

Manual Tuning

Press the ►► or ◀◀ button longer than 2s, will change to manual tuning mode.

Storing a Station

Select a band (if needed), then select a station.

Press and hold a Preset button 1-6 for more than 2 seconds, the current station will be stored to the number.

Automatic Tuning Control (SCAN) (9)

In radio mode, press SCAN button to scan stations, the unit will pause for 5 seconds at each strong radio station. At the desired station press the SCAN again to stop scanning.

A/PS(7)

Short press A/PS button, the unit will scan stored stations in the current band, it pauses for 5 seconds at each preset station.

Long press A/PS button, the unit will search six strong stations and automatically store them on buttons 1-6.

AUX IN PORT

For iPod, MP3 players, and other portable media players.

POWER ON/OFF(1)

Press the button to turn the unit on or off .

SELECT (2)&VOLUME UP/DOWN(3)

Repeatedly press SEL button to select BAS→TRE→BAL→FAD→SUB→EQ→ID3→VOL, then you can use the VOL +/- button to change the setting.

**Long press SEL button to enter zone selection, and short press it again repeatedly to select channel switch, Beep setting, trigger 1/trigger 2 setting, press the VOL + / - to change the settings.**

**a ZONE: AMERICA / EUROPE / CHINA .**

**b STEREO/MONO SWITCH: FM mode.**

**c Beep : Activate Beep on/off.**

**d TRI 1 : Activate Trigger 1(12V\_1) on/off.**

**e TRI 2 : Activate Trigger 2(12V\_2) on/off.**

**Adjust back light(MENU) (16)**

By pressing MENU key more than 2s , you can adjust back light.(25%,100%)

DISPLAY (DISP) (5)

Press DISP button once to display the system time on the LCD.

a. Press and hold DISP button until hour digit starts blinking, use ►► /◀◀ to adjust hour.

b. Press DISP again, minute digit starts blinking, use ►► /◀◀ to adjust minute.

MODE button (MODE) (4)

Press to switch mode: SIRIUS/CDC/AUX/TUNER/DIGI PORT/USB/SD/BT .

LCD display (17)

Display the current state of the unit.

Low Voltage Warning

When the power supply drops down to 10V, it will display "BATTERY LOW" on LCD and beeps for 1 minute, the black box will be turned off automatically in 1 minute.

LOCK THE CONTROL PANEL

Press and hold "SEL" (2)and "DISP"(5) buttons together for 3 seconds to lock the RFX-MR5BB control panel, the Black Box will not response the button press on the panel when the panel is locked. Press and hold "SEL" and "DISP" buttons for 3 seconds again to unlock the RFX,MR5BB control panel.

Press and hold "MUTE" (18)and "Volume Down" (3)button together for 3 seconds to lock RFX-MR7. After locked, RFX-MR7 will not response to any button press. Press and hold the same buttons again to unlock the RFX-MR7.

Note: this function is available for RFX-MR7 made after July 2011.

## Sirius Operation

◆ **This unit is compatible with a variety of SIRIUS Satellite Radio solutions including the SCC1 Sirius Connect Vehicle Tuner and SCVDOC1 Sirius Connect Vehicle Kit with any compatible SIRIUS Dock & Play radio. The operation will be the same regardless of the SIRIUS radio is used .**

◆ User needs follow the instruction of SCC1 or SCVDOC1 for installation. Always make sure the Sirius SIRIUS antenna is connected properly located for maximum signal reception.

### 1. Button definitions

- 1) POWER ON/OFF
- 2) SEL: Function Select button
- 3) VOL+/-: Volume set button
- 4) MODE: Switch between different modes
- 5) DISP: Display the SIRIUS channel info
- 6) SEEK+/-: Short press to select previous/next station, Long press (more than 2 seconds) to switch channel rapidly
- 7) AS/PS: Short press to input channel number directly
- 8) BAND: Switch between SR1, SR2 and SR3
- 9) SCAN: Short press to LOCK/UNLOCK channels, Long press to change the password.
- 10) Preset 1: For preset station 1  
Also used to input the first digit of pass code or channel #.
- 11) Preset 2: For preset station 2  
Also used to input the second digit of pass code or channel #.
- 12) Preset 3: For preset station 3  
Also used to input the third digit of pass code of channel #.
- 13) Preset 4: For preset station 4  
Also used to input the fourth digit of pass code
- 14) Preset 5: For preset station 5
- 15) Preset 6: For preset station 6
- 16) MENU: Short press to turn on/off Category.  
When category is on, you can press "SEL" key to select between categories and then seek in current selected category by pressing SEEK+/- key.
- 17) LCD DISPLAY

## 7. Display channel information:

Press DISP button repeatedly to display different information of the channel such as channel #, channel name, category, song title, artist, composer...

## 8. Message display:

"Check Sirius Tuner":	Tuner is not connected or is bad.
"Antenna Error"	Antenna is bad or not connected.
"Acquiring signal"	No signal output from the Sirius TUNER
"Updating "	Updates the Sirius information into unit.
"FW Updating"	Updates firmware
"Subscription updating"	Updates subscription
"Updating Channels"	Updates the GCI (Channel info)

### IMPORTANT NOTE:

Because of the great variety of products with USB port and sometimes quite manufacturer-specific functions we can neither guarantee that all devices will be recognized nor that all operating options that are possible in theory will actually work.

some USB devices may take more than 45 seconds to initiate after plugging in.



### 6. Parental Control

You can lock any Sirius channels you do not others to have access without your permission. The default code is "5220"if you forget your pass code, you may disconnect the unit completely from power. The unit will restore to the default pass code after power on again. Enter a Locked channel: When user tunes to a locked channel, the LCD screen will display: "LOCKED CH" first and then display: "CODE X X X X".

Press Preset 1 repeatedly to select the first digit of pass code.

Press Preset 2 repeatedly to select the second digit of pass code.

Press Preset 3 repeatedly to select the third digit of pass code.

Press Preset 4 repeatedly to select the last digit of pass code.

When all digits are selected, press "SEL" button will enter the channel.

If the code is wrong, it will display "CODE X X X X" again and wait for user to enter code again. If user enters a wrong code again, the unit will display "PWD ERROR" and go back to previous screen.

**Note:** user needs wait for "CODE X X X X" display to enter pass code. Otherwise the Preset 1-4 still enters as Preset station.

To lock a channel:

When a channel is selected, use "SCAN" to lock this channel. The LCD will display "LOCK CH" first and then display: "CODE X X X X". Use Preset 1-4 (same as above) to enter pass code and press SEL to lock.

**Note:** After a channel is locked, user cannot tune to this channel by SEEK+/- button. User must input the channel # directly to enter this channel.

To unlock a channel:

User needs enter the locked channel first and then short press "SCAN"button.

The LCD will display "UNLOCK CH" and then display: "CODE X X X X".

Same procedure as above to enter the code and unlock the channel.

To change pass code:

Long press "SCAN"button to change the pass code. The screen will display "OLD CODE"shortly and then display "CODE X X X X" Use Preset 1~4 buttons as above to enter the pass code.

If the old pass code is entered correctly, the screen will display "NEW CODE" and then display: "SET X X X X" Use Preset 1-4 buttons again to set up a new pass code.

### 2. Sirius ID and Activate Sirius service

After system is turned on, press the MODE button to enter the SIRIUS mode.

The system will display a "SIRIUS" logo on the LCD screen.

Until you subscribe and activate the SIRIUS service, you can only access channel 0 (the SIRIUS ID channel) and 184 (Preview Channel).

Tune to Channel 0 to display your radio's unique 12-digit SIRIUS ID number (SID).

This number is also available on the back of SIRIUS Tuner SCC1. Write down this number and call 1-888-539-SIRIUS (1-888-539-7474) with your credit card handy to activate SIRIUS service.

You may go to website <https://activate.siriusradio.com//> to activate the service.

If you do not subscribe the full service, the unsubscribed channel will display "CALL 888-539-SIRIUS to subscribe"when tuned.

### 3. Preset Stations

The unit has total 18 preset stations in SIRIUS Mode. Use BAND button to switch between SR1, SR2, and SR3. Each band has 6 preset stations.

Short press the Preset 1~6 button to listen to the preset stations.

Long press the preset 1~6 button to store current station to preset memory.

### 4. Select channels by category

Short press MENU button to turn on/off the category mode. A "CAT" icon in the LCD will indicate the Category mode is on. When Category mode is on, long press "SEEK +/-" to switch between the categories, such as POP, ROCK, COUNTRY, etc. And you can switch channels in selected category by short pressing "SEEK+/-" button. The category mode will not time out unless you turn off this mode by short press MENU button again.

### 5. Input channel directly.

Short press the AS/PS key to enter the direct input mode. The LCD will display: "CH X X XX " Press Preset 1 repeatedly to select the first digit of channel number (the first digit changes incrementally from 0, 1, 2).

Press Preset 2 repeatedly to select the second digit of channel number(the second digit incrementally from 0, 1, 2, ... To 9)

Press Preset 3 repeatedly to select the third digit of the channel number (the third digit changes incrementally from 0, 1, 2, ... To 9).

When 3 digits are selected, press "SEL" button to enter the desired channel.