

**power 360**  
trans • ana  
2-channel

**power 400**  
trans • ana  
4-channel

**power 500**  
trans • ana  
2-channel

**power 800**  
trans • ana  
2-channel

**power 800**  
trans • ana  
4-channel

**power 1000**  
trans • nova  
2-channel



## POWER AMPLIFIER INSTALLATION & OPERATION

# power

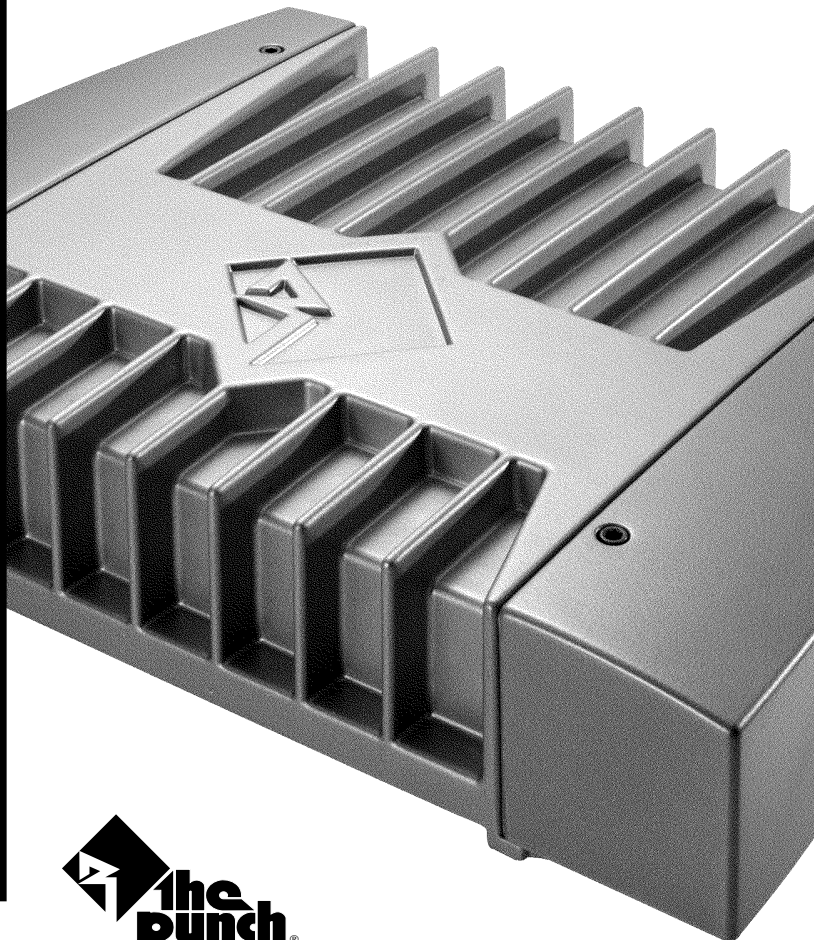

# **SPECIFICATIONS**

## **Dynamic Power Rating**

(IEF-202 Standard) - Measured at 14.4 Volts

Mono into a 4Ω Load

Per channel into a 2Ω Load

Per channel into a 4Ω Load

	POWER 360 2-channel	POWER 400 4-channel	POWER 500 2-channel	POWER 800 2-channel	POWER 800 4-channel	POWER 1000 2-channel
	481 Watts x 1 242 Watts x 2 154 Watts x 2	232 Watts x 2 127 Watts x 4 84 Watts x 4	710 Watts x 1 330 Watts x 2 210 Watts x 2	960 Watts x 1 480 Watts x 2 240 Watts x 2	525 Watts x 2 270 Watts x 4 150 Watts x 4	1460 Watts x 1 730 Watts x 2 450 Watts x 2
	90 Watts x 2	50 Watts x 4	125 Watts x 2	200 Watts x 2	100 Watts x 4	250 Watts x 2
	180 Watts x 2	100 Watts x 4	250 Watts x 2	400 Watts x 2	200 Watts x 4	500 Watts x 2
	360 Watts x 1	200 Watts x 2	500 Watts x 1	800 Watts x 1	400 Watts x 2	1000 Watts x 1
	> 100dB 24dB/octave 50Hz – 210Hz	> 100dB 24dB/octave 50Hz – 210Hz	> 100dB 24dB/octave 50Hz – 210Hz	> 100dB 24dB/octave 50Hz – 210Hz	> 100dB 24dB/octave 50Hz – 210Hz	> 100dB 24dB/octave 50Hz – 210Hz

## **Continuous Power Rating**

(Competition Standard) - Measured at 13.8 Battery Volts

**RMS continuous power per channel**, both channels driven into a 4Ω load from 20 to 20,000 Hz with less than 0.05% Total Harmonic Distortion (THD)

**RMS continuous power per channel**, both channels driven into a 2Ω load from 20 to 20,000 Hz, with less than 0.1% Total Harmonic Distortion (THD)

**RMS continuous power mono** into a 4Ω load from 20 to 20,000 Hz, with less than 0.1% Total Harmonic Distortion (THD)

**Signal-to-Noise Ratio (A-weighted)**  
**Crossover Slope (Butterworth)**  
**Crossover Frequency**

*Specifications are subject to change without notice.*

	<b>POWER 360</b> 2-channel 2.62" (6.65cm) H 9.60" (24.38cm) W 12.27" (31.16cm) L #3	<b>POWER 400</b> 4-channel 2.62" (6.65cm) H 9.60" (24.38cm) W 13.27" (33.70cm) L #4	<b>POWER 500</b> 2-channel 2.62" (6.65cm) H 9.60" (24.38cm) W 13.27" (33.70cm) L #4	<b>POWER 800</b> 2-channel 2.62" (6.65cm) H 9.60" (24.38cm) W 18.27" (46.40cm) L #6	<b>POWER 800</b> 4-channel 2.62" (6.65cm) H 9.60" (24.38cm) W 18.27" (46.40cm) L #6	<b>POWER 1000</b> 2-channel 2.62" (6.65cm) H 9.60" (24.38cm) W 18.27" (46.40cm) L #6
Dimensions (end caps installed)						
Heatsink Type (internal use only)						
Frequency Response ( $\pm 0.5$ dB)	20Hz - 20kHz	20Hz - 20kHz	20Hz - 20kHz	20Hz - 20kHz	20Hz - 20kHz	20Hz - 20kHz
Bandwidth ( $\pm 3$ dB)	20Hz - 200kHz	20Hz - 200kHz	20Hz - 200kHz	20Hz - 200kHz	20Hz - 200kHz	20Hz - 200kHz
Damping Factor @ 4 $\Omega$ (at output connector)	>200	>200	>200	>200	>200	>200
Slew Rate	30 Volts/ $\mu$ s	30 Volts/ $\mu$ s	30 Volts/ $\mu$ s	30 Volts/ $\mu$ s	30 Volts/ $\mu$ s	30 Volts/ $\mu$ s
IM Distortion (IHF)	<0.05%	<0.05%	<0.05%	<0.05%	<0.05%	<0.05%
Source Unit Compatibility ( $\pm 15$ dB gain overlap)	17V max. (RCA)	17V max. (RCA)	17V max. (RCA)	17V max. (RCA)	17V max. (RCA)	17V max. (RCA)
Input Sensitivity ( $\pm 0$ dB gain overlap)	250mV - 4V (RCA)	250mV - 4V (RCA)	250mV - 4V (RCA)	250mV - 4V (RCA)	250mV - 4V (RCA)	250mV - 4V (RCA)
Protection	NOMAD - Internal analog-computer output protection circuitry limits power in case of overload. Thermal switch shuts down the amplifier in case of overheating.					
Battery Fuse Rating (External to Amplifier)	40A	50A	50A	60A*	60A*	2-50A or 1-100A*
Fuse Type	ATC	AGU	AGU	AGU	AGU	2-AGU OR 1 - ANL
Equalization (45Hz Punch Bass)	Variable (0 to +18dB)	Rear Variable (0 to +18dB)	Variable (0 to +18dB)	Variable (0 to +18dB)	Rear Variable (0 to +18dB)	Variable (0 to +18dB)
Input Impedance	20K ohms	20K ohms	20K ohms	20K ohms	20K ohms	20K ohms

\* recommended fuse not supplied with amplifier

Specifications are subject to change without notice.

*Dear Customer,*

*Congratulations on your purchase of the world's finest brand of car audio amplifiers. At Rockford Fosgate we are fanatics about musical reproduction at its best, and we are pleased you chose our product. Through years of engineering expertise, hand craftsmanship and critical testing procedures, we have created a wide range of products that reproduce music with all the clarity and richness you deserve.*

*For maximum performance we recommend you have your new Rockford Fosgate product installed by an Authorized Rockford Fosgate Dealer, as we provide specialized training through Rockford Technical Training Institute (RTTI). Please read your warranty and retain your receipt and original carton for possible future use.*

*Great product and competent installations are only a piece of the puzzle when it comes to your system. Make sure that your installer is using 100% authentic installation accessories from Connecting Punch in your installation. Connecting Punch has everything from RCA cables and speaker wire to Power line and battery connectors. Insist on it! After all, your new system deserves nothing but the best.*

*To add the finishing touch to your new Rockford Fosgate image order your Rockford wearables, which include everything from T-shirts and jackets to hats and sunglasses.*

*To get a free brochure on Rockford Fosgate products and Rockford accessories, in the U.S. call 480-967-3565 or FAX 480-967-8132. For all other countries, call +001-480-967-3565 or FAX +001-480-967-8132.*

## **PRACTICE SAFE SOUND™**

**CONTINUOUS EXPOSURE TO SOUND PRESSURE LEVELS OVER 100dB  
MAY CAUSE PERMANENT HEARING LOSS. HIGH POWERED AUTOSOUND  
SYSTEMS MAY PRODUCE SOUND PRESSURE LEVELS WELL OVER  
130dB. USE COMMON SENSE AND PRACTICE SAFE SOUND.**

If, after reading your manual, you still have questions regarding this product, we recommend that you see your Rockford Fosgate dealer. If you need further assistance, you can call us direct at 1-800-669-9899. Be sure to have your serial number, model number and date of purchase available when you call.

The serial number can be found on the outside of the box. Please record it in the space provided below as your permanent record. This will serve as verification of your factory warranty and may become useful in recovering your amplifier if it is ever stolen.

Serial Number: \_\_\_\_\_

Model Number: \_\_\_\_\_

# TABLE OF CONTENTS

---

Specifications.....	i
Introduction .....	1
Power Amplifier Accessory Pack .....	1
Feature Chart .....	2
Design Features .....	3
Installation Considerations .....	7
Mounting Location .....	8
Battery and Charging .....	9
Wiring the System .....	9
Using Passive Crossovers .....	11
Table of Component Values .....	12
Installation .....	13
Operation .....	21
System Diagrams .....	24
Troubleshooting .....	28
Dynamic Power Measurements .....	31
Warranty Information .....	33
International Information .....	34

## GETTING STARTED

Welcome to Rockford Fosgate! This manual is designed to provide information for the owner, salesperson and installer. For those of you who want quick information on how to install this product, please turn to the **Installation Section** of this manual or refer to the icons listed below. Other information can be located by using the Table of Contents. We, at Rockford Fosgate, have worked very hard to make sure all the information in this manual is current. But, as we are constantly finding new ways to improve our product, this information is subject to change without notice.



Sections marked  
**ADVANCED OPERATION**  
include in-depth  
technical information

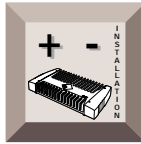

Sections marked  
**INSTALLATION**  
include "slam dunk"  
wiring connections



Sections marked  
**TROUBLESHOOTING**  
include recommendations for  
curing installation problems

# INTRODUCTION

---

Rockford engineers designed the Power amplifiers to provide an awesome amount of power while delivering superior sound quality in a convenient and efficient package. The TRANS•ana & patented TRANS•nova topologies are low voltage circuits used in the preamp stage of the Power amplifiers that let the music sound crystal clear and very real, even when played at high volume levels. This is matched with TOPAZ, a unique grounding circuit used to eliminate noise problems associated with car audio systems and their installation. The use of a protection circuit called NOMAD, along with MOSFET, DSM (Discrete Surface Mount) and innovative MEHSA heat dissipating technologies improves amplifier efficiency. The result of these components give the Power amplifier awesome sound quality in a "Bullet Proof" package.

## POWER AMPLIFIER ACCESSORY PACK

---

The accessory pack shipped with the Power amplifiers includes the mounting hardware necessary to secure the amp to the vehicle.

Installation & Operation Manual

Punch Verification Certificate

- (4) Amplifier mounting screws (#8 x 3/4" Phillips)
- (4) Speaker/Power connector set screws (3/32" Allen)
- (4) Endbell mounting screws (9/64" Allen)
- (1) Allen wrench (3/32")
- (1) Allen wrench (9/64")
- (1) Inline fuseholder (Power 360, Power 400 & Power 500 2-channel amps)
- (1) AGU 40 amp fuse (Power 360 2-channel amp)
- (1) AGU 50 amp fuse (Power 400 4-channel & Power 500 2-channel amps)
- (1) Remote Punch Bass (replacement part #WP-2429)
- (1) 15' Remote Punch Bass cable (replacement part #CC-2421)
- (2) Remote Punch Bass bracket screws (4 x 7/16" Phillips)

*NOTE: Refer to the specifications section for recommended fuse sizes on the Power 800 2-channel, Power 800 4-channel & Power 1000 2-channel amps.*

# POWER AMPLIFIER FEATURE CHART

POWER AMPLIFIER MODEL	Power 360	Power 400	Power 500	Power 800	Power 800	Power 1000
# of CHANNELS	2	4	2	2	4	2
Stable Into: (stereo/mono)	2Ω/4Ω	2Ω/4Ω	2Ω/4Ω	2Ω/4Ω	2Ω/4Ω	2Ω/4Ω
<b>CIRCUITRY<sup>1</sup></b>						
TRANS• <i>ana</i> – circuit topology	X	X	X	X	X	–
TRANS• <i>nova</i> – patented circuit topology <sup>2</sup>	–	–	–	–	–	X
DIAMOND – patented MOSFET driver stage <sup>3</sup>	–	–	–	–	–	X
Class-G – high efficiency topology	–	–	–	–	–	–
MEHSA – heat dissipating technology	X	X	X	X	X	X
TOPAZ – patented noise eliminating circuitry <sup>4</sup>	X	X	X	X	X	X
DSM – discrete surface mount	X	X	X	X	X	X
MOSFETS – power supply & output devices	X	X	X	X	X	X
NOMAD – protection circuit	X	X	X	X	X	X
<b>FEATURES</b>						
Die Cast Heatsink <sup>5</sup>	X	X	X	X	X	X
Hi-Level Inputs – for factory radios	–	–	–	–	–	–
RCA Inputs – for aftermarket radios	X	X	X	X	X	X
Input Switches – eliminates “Y” adaptors	–	X	–	–	X	–
Pass-Thru – feeds signal to aux. amp	X	X	X	X	X	X
Pwr/Spk Screw Terminals	–	–	–	–	–	–
Pwr/Spk Block Terminals	X	X	X	X	X	X
4 Gauge PWR/GND	X	X	X	X	X	X
Variable Punch Bass (0dB – +18dB @ 45Hz)	Remote	Remote Rear	Remote	Remote	Remote Rear	Remote
Variable Xover (50Hz – 210Hz)	HP/FULL/LP <sup>6</sup>	HP/FULL/LP <sup>6</sup>	HP/FULL/LP <sup>6</sup>	HP/FULL/LP <sup>6</sup>	HP/FULL/LP <sup>6</sup>	HP/FULL/LP <sup>6</sup>
Crossover Slope (Butterworth)	24dB	24dB	24dB	24dB	24dB	24dB
Phase Warp (0° – 180°)	–	–	–	–	–	X

<sup>1</sup> Additional information on features, specifications and system designs can be found at: [www.rockfordfosgate.com](http://www.rockfordfosgate.com)

<sup>2</sup> Trans•nova is patented under “U.S. Patent No. 4,467,288”

<sup>3</sup> DIAMOND is patented under “U.S. Patent No. 5,673,000”

<sup>4</sup> TOPAZ is patented under “U.S. Patent No. 5,751,823”

<sup>5</sup> Diecast Heatsink is patented under “U.S. Patent No. D401,225”

<sup>6</sup> HP = 24dB/octave High-Pass / LP = 24dB/octave Low-Pass / FULL = Full Range

<sup>7</sup> Recommended fuses not supplied with amplifier

# DESIGN FEATURES

## Power 360 2 - channel

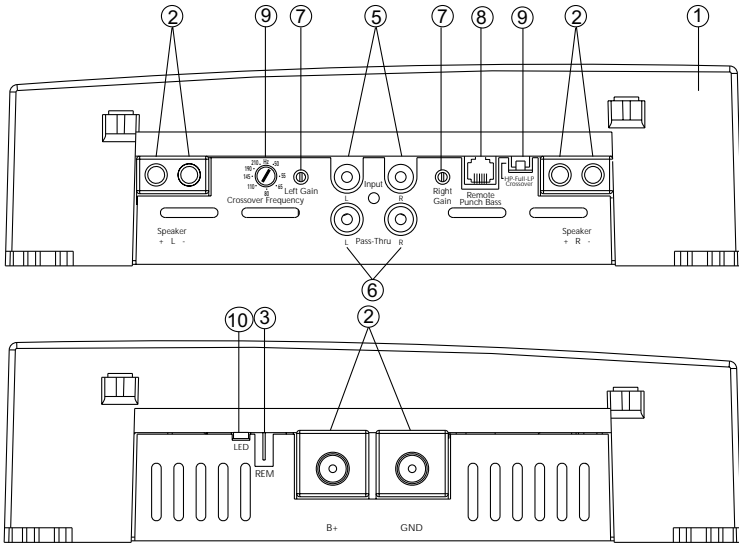

## Power 400 4 - channel

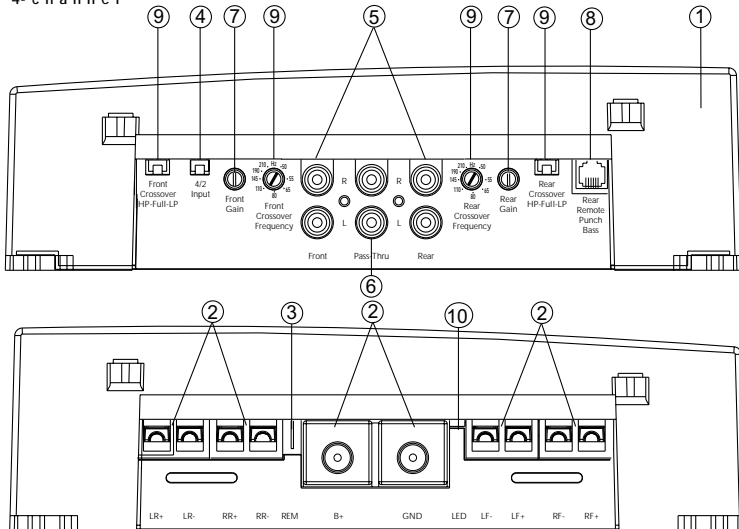



**Power 500**  
2 - channel

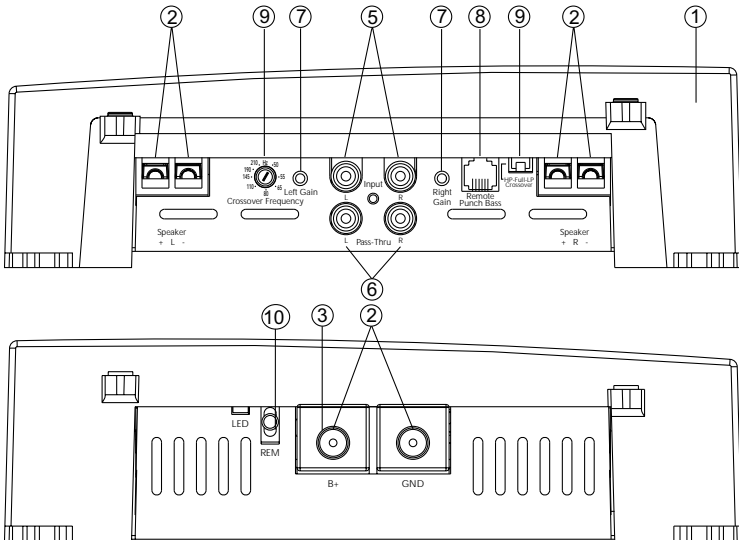

**Power 800**  
2 - channel

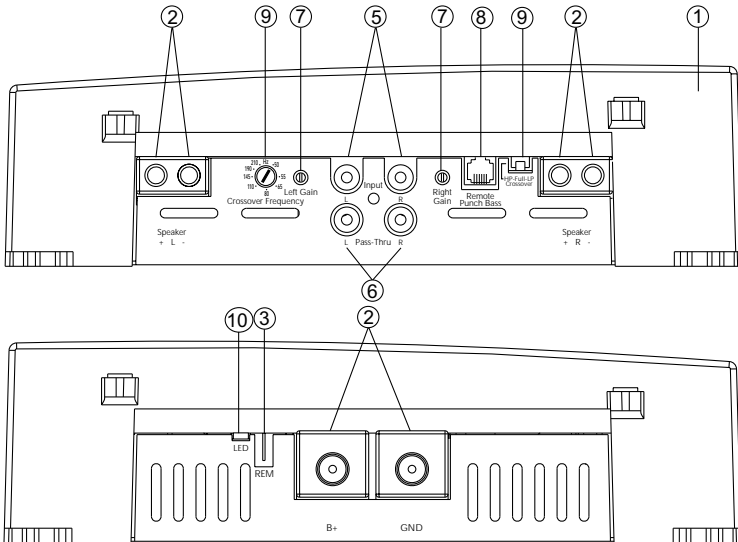

## Power 800

4 - channel

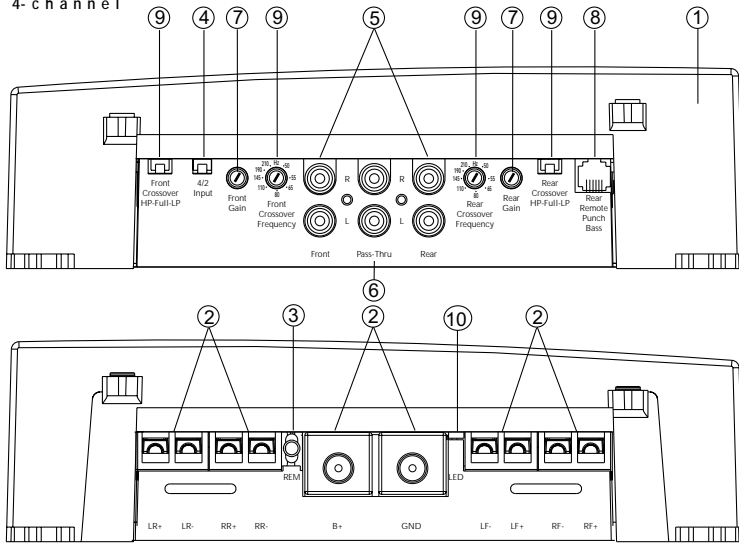

## Power 1000

2 - channel

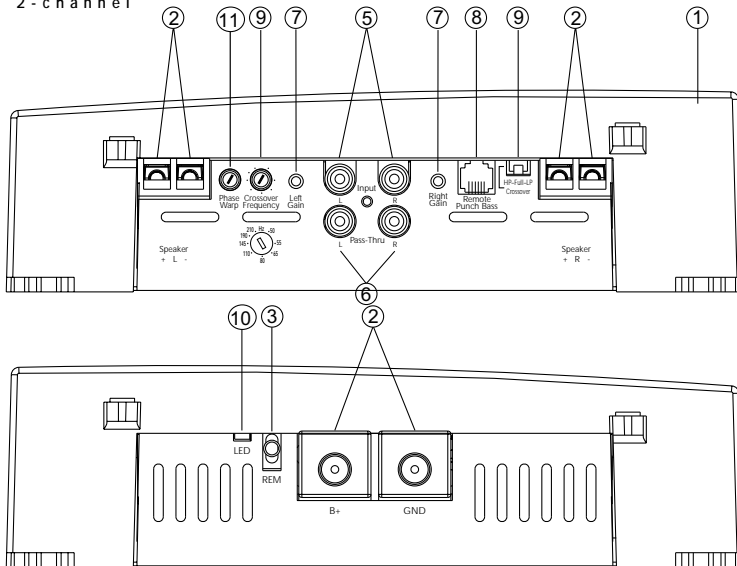

1. **Cast Aluminum Heatsink** – The cast aluminum heatsink of the Power amplifier dissipates heat generated by the amplifier's circuitry. The inherent advantage of casting provides a 30% improvement of cooling over conventional extrusion heatsink designs.
2. **Speaker/Power Terminals** – The heavy duty, gold-plated terminal block connectors (+ and –) will accept 4 gauge cable and are immune to corrosion that can cause signal degradation.
3. **REM Terminal** – This spade terminal is used to remotely turn on and turn off the amplifier when +12V DC is applied.
4. **Signal Input Switch** (Power 400 & Power 800 4-channel amplifiers) – This switch allows the amplifier to be driven with either 2 or 4 pairs of inputs.
5. **RCA Input Jacks** – The industry standard RCA jacks provide an easy connection for signal level input. They are gold-plated to resist the signal degradation caused by corrosion.
6. **RCA Pass-Thru Jacks** – The Pass-Thru provides a convenient source for daisy-chaining an additional amplifier without running an extra set of RCA cables from the front of the vehicle to the rear amplifier location.
7. **Gain Control** – The input gain control is preset to match the output of most source units. It can be adjusted to match output levels from a variety of source units.
8. **Remote Punch Bass** – The Punch Bass helps correct for acoustical deficiencies in the listening environment by helping reproduce full range sound without adding excessive boost. The Punch Bass control is a narrow band adjustment centered at 45Hz variable from 0dB to +18dB. Connection is made with a cable using RJ-45 and can be installed under the dash for remote control access.
9. **Internal Crossover** – The internal crossover is a 24dB/octave Butterworth filter selectable for High-Pass (HP), Full Range (FULL), or Low-Pass (LP) operation variable from 50Hz to 210Hz.
10. **LED Power Indicator** – The LED illuminates when the unit is turned on.
11. **Phase Warp** (Power 1000 2-channel amplifier) – The phase warp is a variable control used to adjust the phase of the output signal relative to the phase of the input signal. The phase warp is most noticeable when the system is playing a sine wave (test tone). When used with the proper test equipment, this feature can increase the relative SPL in a system.

# INSTALLATION CONSIDERATIONS

---

The following is a list of tools you will need for installing the Power amplifier:

Voltmeter	Wire strippers
Electric hand drill w/assorted bits	Battery post wrench
17' (5 m) Red Power Wire	Wire cutters
12' (4 m) Remote Turn-On Wire	Assorted connectors
1.5' (45 cm) Black Grounding Wire	Wire crimpers

This section focuses on some of the vehicle considerations for installing your new Power amplifier. Checking your battery and present sound system, as well as pre-planning your system layout and best wiring routes, will save installation time. When deciding how to lay out your new system, be sure that each component will be easily accessible for making adjustments.

Before beginning any installation, be sure to follow these simple rules:

1. Be sure to carefully read and understand the instructions before attempting to install the amplifier.
2. **For safety**, disconnect the negative lead from the battery prior to beginning the installation.
3. For easier assembly, we suggest you run all wires prior to mounting your amplifier in place.
4. Route all of the RCA cables close together and away from any high current wires.
5. Use high quality connectors for a reliable installation and to minimize signal or power loss.
6. **Think before you drill!** Be careful not to cut or drill into gas tanks, fuel lines, brake or hydraulic lines, vacuum lines or electrical wiring when working on any vehicle.
7. Never run wires underneath the vehicle. Running the wires inside the vehicle provides the best protection.
8. Avoid running wires over or through sharp edges. Use rubber or plastic grommets to protect any wires routed through metal, especially the firewall.
9. **ALWAYS** protect the battery and electrical system from damage with proper fusing. Install a fuseholder and appropriate fuse on the +12V power wire within 18" (45 cm) of the battery terminal.
10. When grounding to the chassis of the vehicle, scrape all paint from the metal to ensure a good, clean ground connection. Grounding connections should be as short as possible and always be connected to metal that is welded to the main body, or chassis, of the vehicle.

# MOUNTING LOCATION

---

The mounting location and position of your amplifier will have a great effect on its ability to dissipate the heat generated during normal operation. The design of our cast aluminum heatsink serves to easily dissipate the heat generated over a wide range of operating conditions. However, to maximize the performance of your amplifier, care should be taken to ensure adequate ventilation.

## Trunk Mounting

Mounting the amplifier vertically on a surface with the fin grooves running up and down will provide the best cooling of the amplifier.

Mounting the amplifier on the floor of the trunk will work but provides less cooling capability than vertical mounting.

Mounting the amplifier upside down to the rear deck of the trunk will not provide proper cooling and will severely affect the performance of the amplifier and is strongly *not* recommended.

## Passenger Compartment Mounting

Mounting the amplifier in the passenger compartment will work as long as you provide a sufficient amount of air for the amplifier to cool itself. If you are going to mount the amplifier under the seat of the vehicle, you must have at least 1" (2.54cm) of air gap around the amplifier's heatsink.

Mounting the amplifier with less than 1" (2.54cm) of air gap around the amplifier's heatsink in the passenger compartment will not provide proper cooling and will severely affect the performance of the amplifier and is strongly *not* recommended.

## Engine Compartment Mounting

Rockford Fosgate amplifiers should *never* be mounted in the engine compartment. Not only will this void your warranty but could create an embarrassing situation caused by the ridicule from your friends.

# BATTERY AND CHARGING

---

Amplifiers will put an increased load on the vehicle's battery and charging system. We recommend checking your alternator and battery condition to ensure that the electrical system has enough capacity to handle the increased load of your stereo system. Stock electrical systems which are in good condition should be able to handle the extra load of any Rockford amplifier without problems, although battery and alternator life can be reduced slightly. To maximize the performance of your Rockford Fosgate amplifier, we suggest the use of a heavy duty battery and an energy storage capacitor.

# WIRING THE SYSTEM

---

**CAUTION:** Avoid running power wires near the low level input cables, antenna, power leads, sensitive equipment or harnesses. The power wires carry substantial current and could induce noise into the audio system.

1. Plan the wire routing. Take care when running signal level RCA cables to keep them close together but isolated from the amplifier's power cables and any high power auto accessories, especially electric motors. This is done to prevent coupling the noise from radiated electrical fields into the audio signal. When feeding the wires through the firewall or any metal barrier, protect them with plastic or rubber grommets to prevent short circuits. Leave the wires long at this point to adjust for a precise fit at a later time.

2. Prepare the **Power** cable for attachment to the amplifier by stripping 5/8" of insulation from the end of the wire. The use of 8 gauge power cable can interfere with the installation of the end caps. Proper wire dress can prevent this from occurring. To prevent the wire from fraying, strip the insulation at a 45° angle.

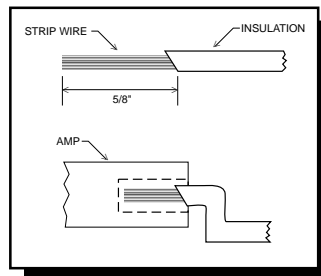

angle. Insert the bared wire into the B+ terminal with the long side of the insulation on the top. Bend the cable down at a 90° angle. Tighten the set screw to secure the cable in place.

3. Strip 3/8" from the battery end of the power cable and crimp a large ring terminal to the cable. Use the ring terminal to connect to the battery positive terminal. **Do not install the fuse at this time.**

4. Prepare a length of cable to be used for the ground connection. Strip 5/8" of insulation from the end of the cable as described above and connect to the appropriate terminal of the amplifier. Prepare the chassis ground by scraping any paint from the metal surface and thoroughly clean the area of all dirt and grease. Strip the other end of the wire and attach a ring connector. Fasten the cable to the chassis using a non-anodized screw and a star washer.
5. Prepare the REM turn-on wire for connection to the amplifier by stripping 1/4" of insulation from the wire end and crimping an insulated spade connector in place. Slide the connector over the REM terminal on the amplifier. Connect the other end of the REM wire to a switched 12 volt positive source. The switched signal is usually taken from the source unit's auto antenna or the accessory lead. If the source unit does not have these outputs available, the recommended solution is to wire a mechanical switch in line with a 12 volt source to activate the amplifier.
6. Securely mount the amplifier (with supplied screws) to the vehicle or amp rack. Be careful not to mount the amplifier on cardboard or plastic panels. Doing so may enable the screws to pull out from the panel due to road vibrations or sudden vehicle stops.
7. Determine the number of inputs needed to drive the amplifier and move the input switch to the desired setting (Power 400 & Power 800 4-channel amplifiers only.).
8. Connect the source signal to the amplifier by plugging the RCA cables into the input jack(s) at the amplifier.
9. Connect the speakers. Strip the speaker wires 5/8" and insert into the appropriate terminal on the amplifier. Insert the bared wire into the speaker terminal and tighten the set screw to secure into place. Be sure to maintain proper speaker polarity. ***DO NOT chassis ground any of the speaker leads as unstable operation may result.***
10. Perform a final check of the completed system wiring to ensure that all connections are accurate. Check all power and ground connections for frayed wires and loose connections which could cause problems from road vibrations.

# USING PASSIVE CROSSOVERS

---



A passive crossover is a circuit that uses capacitors and/or coils and is placed on speaker leads between the amplifier and speaker. The crossover delegates a specific range of frequencies to the speaker for optimum driver performance. A crossover network can perform one of three functions: High-Pass (capacitors), Low-Pass (inductors or coils) and Bandpass (combination of capacitor and coil).

The most commonly used passive crossover networks are 6dB/octave systems. These are easy to construct and require one component per filter. Placing this filter in series with the circuit will reduce power to the speaker by 6dB/octave above or below the crossover point depending on whether it is a high-pass or low-pass filter. More complex systems such as 12dB/octave or 18dB/octave can cause impedance problems if not professionally designed.

Passive crossovers are directly dependent upon the speaker's impedance and component value for accuracy. When passive crossover components are used in multiple speaker systems, the crossover's effect on the overall impedance should be taken into consideration along with the speaker's impedance when determining amplifier loads. ***CAUTION: The Power amplifiers are not recommended for impedance loads below 2Ω stereo and 4Ω bridged (mono) loads.***



# TABLE OF CROSSOVER COMPONENT VALUES

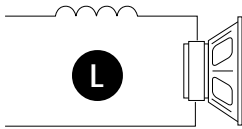

6dB/Octave Low-Pass

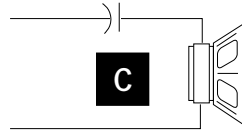

6dB/Octave High-Pass

Freq. Hertz	Speaker Impedance					
	2 OHMS		4 OHMS		8 OHMS	
	<b>L</b>	<b>C</b>	<b>L</b>	<b>C</b>	<b>L</b>	<b>C</b>
80	4.1mH	1000 $\mu$ F	8.2mH	500 $\mu$ F	16mH	250 $\mu$ F
100	3.1mH	800 $\mu$ F	6.2mH	400 $\mu$ F	12mH	200 $\mu$ F
130	2.4mH	600 $\mu$ F	4.7mH	300 $\mu$ F	10mH	150 $\mu$ F
200	1.6mH	400 $\mu$ F	3.3mH	200 $\mu$ F	6.8mH	100 $\mu$ F
260	1.2mH	300 $\mu$ F	2.4mH	150 $\mu$ F	4.7mH	75 $\mu$ F
400	.8mH	200 $\mu$ F	1.6mH	100 $\mu$ F	3.3mH	50 $\mu$ F
600	.5mH	136 $\mu$ F	1.0mH	68 $\mu$ F	2.0mH	33 $\mu$ F
800	.41mH	100 $\mu$ F	.82mH	50 $\mu$ F	1.6mH	26 $\mu$ F
1000	.31mH	78 $\mu$ F	.62mH	39 $\mu$ F	1.2mH	20 $\mu$ F
1200	.25mH	66 $\mu$ F	.51mH	33 $\mu$ F	1.0mH	16 $\mu$ F
1800	.16mH	44 $\mu$ F	.33mH	22 $\mu$ F	.68mH	10 $\mu$ F
4000	.08mH	20 $\mu$ F	.16mH	10 $\mu$ F	.33mH	5 $\mu$ F
6000	51 $\mu$ H	14 $\mu$ F	.10mH	6.8 $\mu$ F	.20mH	3.3 $\mu$ F
9000	34 $\mu$ H	9.5 $\mu$ F	68 $\mu$ H	4.7 $\mu$ F	.15mH	2.2 $\mu$ F
12000	25 $\mu$ H	6.6 $\mu$ F	51 $\mu$ H	3.3 $\mu$ F	100 $\mu$ H	1.6 $\mu$ F

L = Low-Pass (Inductor)  
C = High-Pass (Capacitor)

For more information, see your Authorized Rockford Fosgate Dealer.

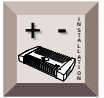

# INSTALLATION

POWER 360 2-CHANNEL

POWER 500 2-CHANNEL

POWER 800 2-CHANNEL

## Power Connections

Power 360  
2-channel

Power 500  
2-channel

Power 800  
2-channel

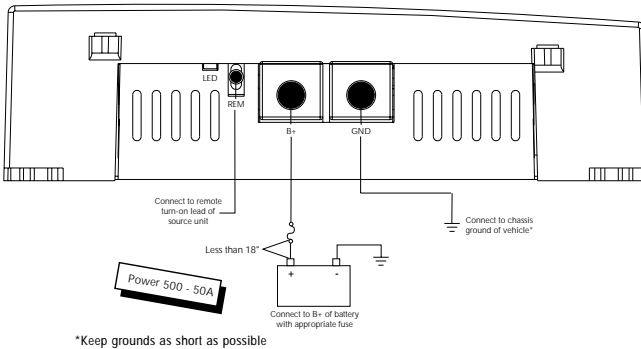

## Bridged/Mono Mode

Power 360  
2-channel

Power 500  
2-channel

Power 800  
2-channel

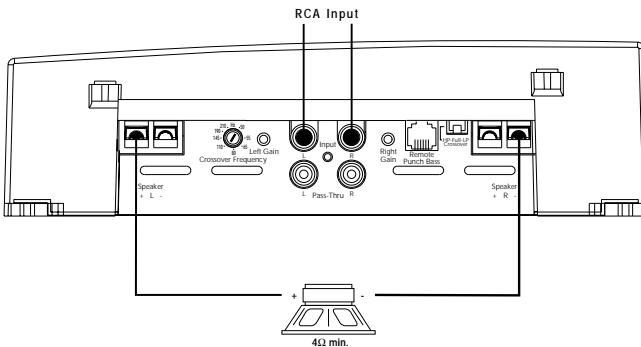

- **RCA Inputs** connect to both left and right channels
- **Gain** for left and right channels are set equally to balance the subwoofer
- **Speaker Impedance** should be 4Ω minimum
- **Variable Crossover** can be set to High-Pass (HP), Low-Pass (LP) or Full Range (FULL)

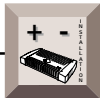

## 2-Channel Mode

Power 360  
2 - channel

Power 500  
2 - channel

Power 800  
2 - channel

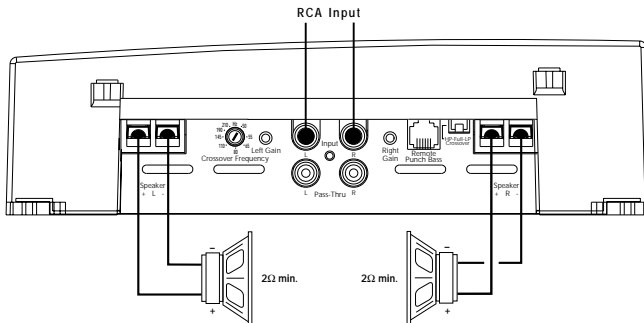

- **RCA Inputs** connect to both left and right channels
- **Gain** for left and right channels operate independently
- **Speaker Impedance** for each channel should be  $2\Omega$  minimum
- **Variable Crossover** can be set to High-Pass (HP), Low-Pass (LP) or Full Range (FULL)

## 3-Channel Mode

Power 360  
2 - channel

Power 500  
2 - channel

Power 800  
2 - channel

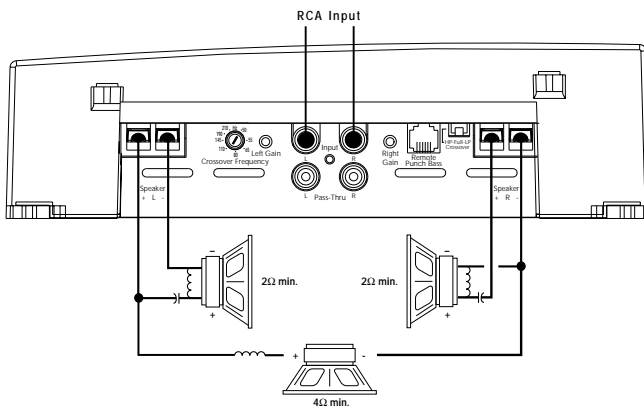

- **RCA Inputs** connect to both left and right channels
- **Gain** for left and right channels are set equally to balance the subwoofer
- **Speaker Impedance** for each stereo channel should be  $2\Omega$  minimum
- **Speaker Impedance** for bridged/mono channel should be  $4\Omega$  minimum
- **Variable Crossover** must be set for Full Range (FULL)
- **Passive Crossovers** must be used for proper stereo/mono operation

# INSTALLATION

POWER 400 4-CHANNEL

POWER 800 4-CHANNEL



## Power Connections

Power 400  
4 - channel

Power 800  
4 - channel

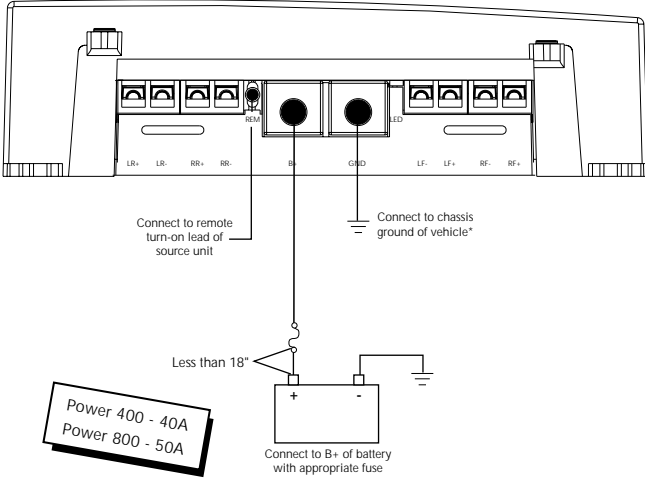

\*Keep grounds as short as possible

## 2-Channel Mode

Power 400    Power 800  
4-channel    4-channel

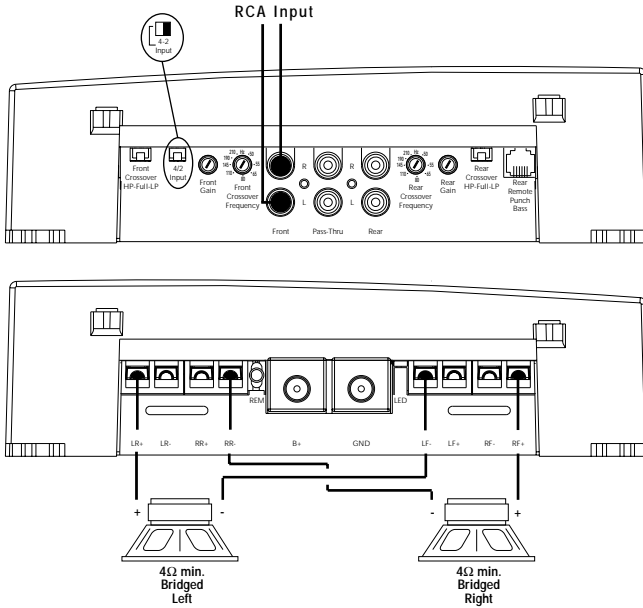
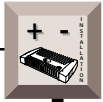

- **RCA Inputs** are connected to front inputs
- **4-2 Input Switch** is set to 2-channel input mode
- **Gain** for front and rear channels must be set identical
- **Speaker Impedance** for each bridged channel should be no less than 4Ω
- **Variable Crossovers** for front and rear channels must be set to identical frequency (i.e. both set to 60Hz) and operating mode (i.e. both set to LP)



### 3-Channel Mode

Power 400    Power 800  
4 - channel    4 - channel

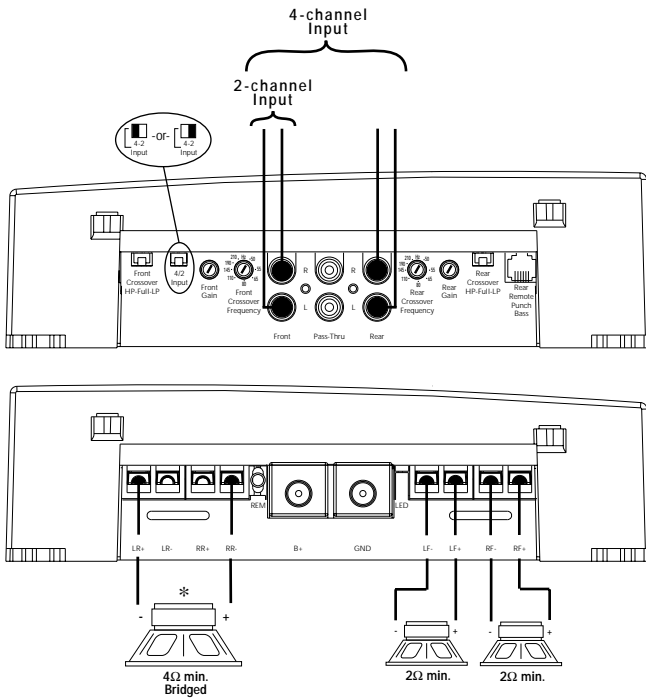

- **RCA Inputs** are connected to front -or- front/rear inputs
- **4-2 Input Switch** is set to 2-channel -or- 4-channel input mode
- **Gain** for front and rear channels operate independently
- **Speaker Impedance** for each front stereo channel should be no less than 2Ω
- **Speaker Impedance** for rear bridged/mono channel should be no less than 4Ω
- **Variable Crossovers** for front & rear are variable from 50Hz~210Hz and can be set to HP (High-Pass), LP (Low-Pass) or FULL (Full Range)

\* Reverse polarity on subwoofer if front channel is set to HP (High-Pass) and rear channel is set to LP (Low-Pass)

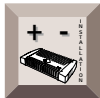

## 4-Channel Mode

Power 400    Power 800  
4 - channel    4 - channel

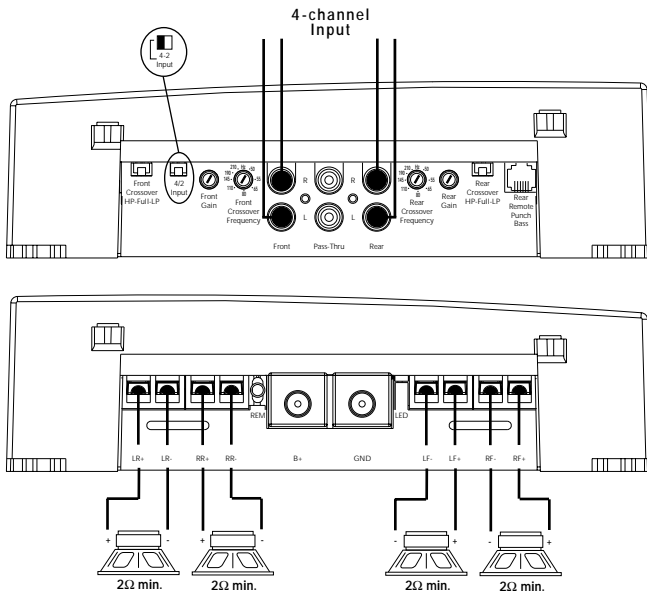

- **RCA Inputs** are connected to front & rear inputs
- **4-2 Input Switch** is set to 4-channel input mode
- **Gain** for front and rear channels operate independently
- **Speaker Impedance** for all stereo channels should be no less than 2Ω
- **Variable Crossovers** for front & rear are variable from 50Hz~210Hz and can be set to HP (High-Pass), LP (Low-Pass) or FULL (Full Range)

# INSTALLATION

## POWER 1000 2-CHANNEL



### Power Connections

Power 1000  
2 - channel

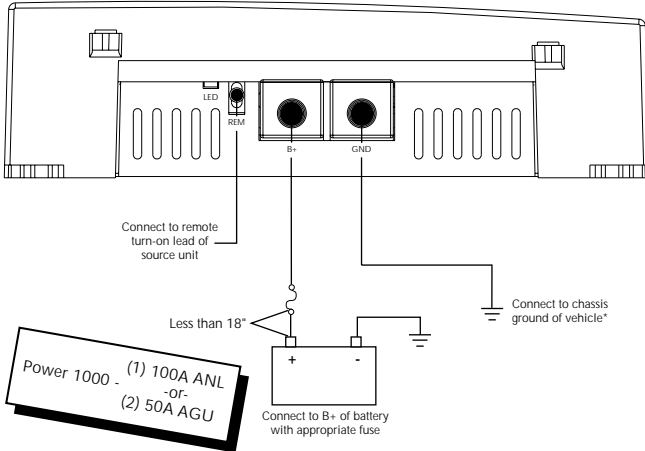

\*Keep grounds as short as possible

### Bridged/Mono Mode

Power 1000  
2 - channel

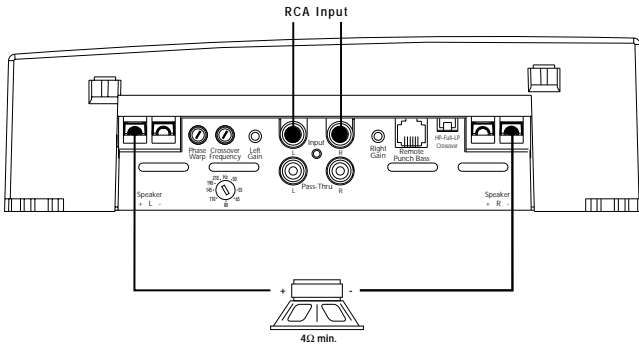

- **RCA Inputs** connect to both left and right channels
- **Gain** for left and right channels are set equally to balance the subwoofer
- **Speaker Impedance** should be  $4\Omega$  minimum
- **Variable Crossover** can be set to High-Pass (HP), Low-Pass (LP) or Full Range (FULL)



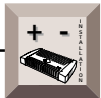

## 2-Channel Mode

Power 1000  
2 - channel

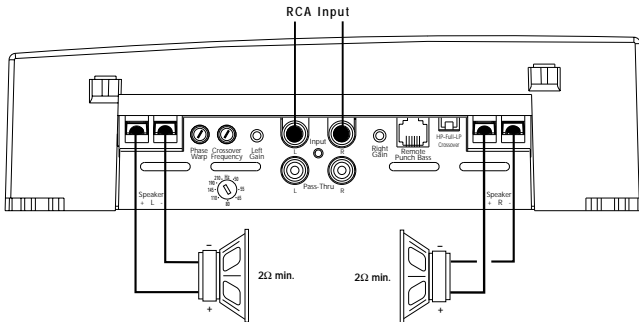

- **RCA Inputs** connect to both left and right channels
- **Gain** for left and right channels operate independently
- **Speaker Impedance** for each channel should be 2Ω minimum
- **Variable Crossover** can be set to High-Pass (HP), Low-Pass (LP) or Full Range (FULL)

## 3-Channel Mode

Power 1000  
2 - channel

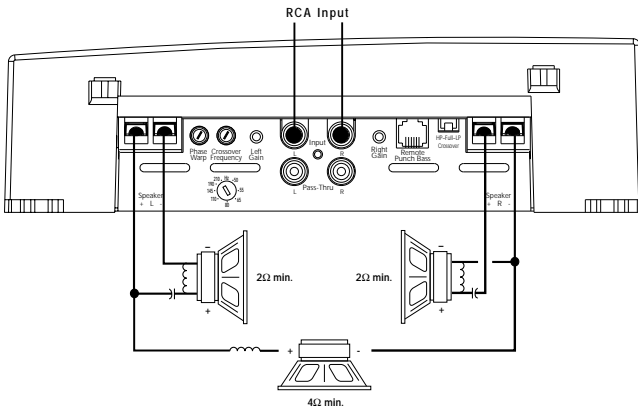

- **RCA Inputs** connect to both left and right channels
- **Gain** for left and right channels are set equally to balance the subwoofer
- **Speaker Impedance** for each stereo channel should be 2Ω minimum
- **Speaker Impedance** for bridged/mono channel should be 4Ω minimum
- **Variable Crossover** must be set for Full Range (FULL)
- **Passive Crossovers** must be used for proper stereo/mono operation

# OPERATION



## Crossover Operation

All Models

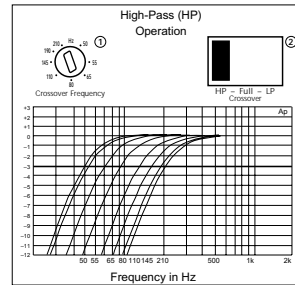
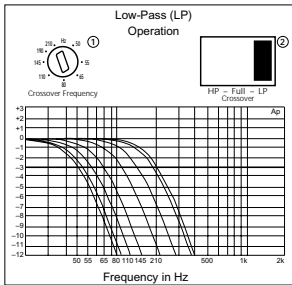
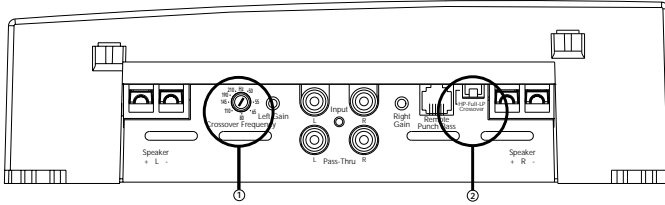

- **HP Operation** enables frequencies above the cut-off point to pass to the speaker
- **FULL Operation** enables all frequencies to pass to the speaker
- **LP Operation** enables frequencies below the cut-off point to pass to the speaker



## Remote Punch Bass

All Models

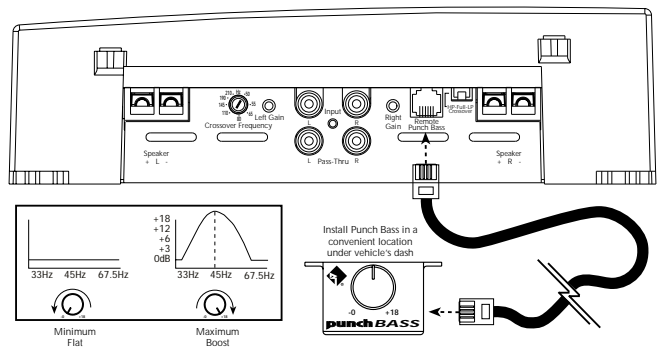

- Carefully increase potentiometer to add Punch to your bass frequencies
- Exercise caution when increasing Punch Bass. Maximum boost can cause potential woofer damage caused by overexcursion

## Pass-Thru

All Models

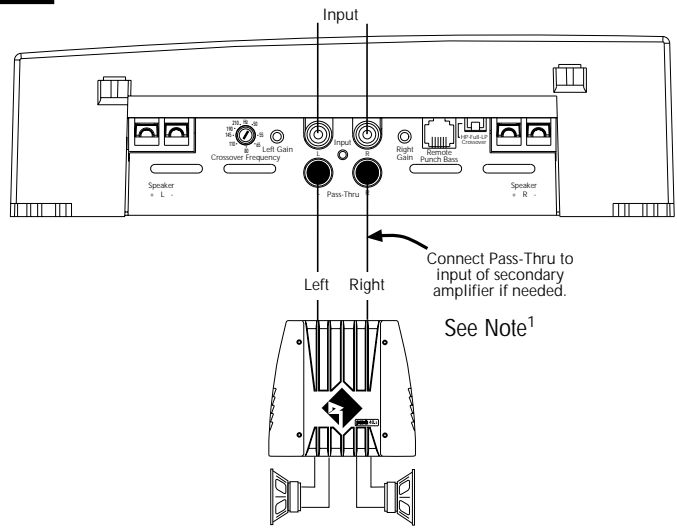

- Pass-Thru feeds signal to secondary amplifier
- Signal from Pass-Thru remains stereo

**Note<sup>1</sup>:** If using High Level Inputs causes engine whine in an amplifier connected to the Pass-Thru, the Pass-Thru amplifier should have its RCA input shield connected to the radio chassis ground. Refer to the Troubleshooting section of this manual for more information.



## Phase Warp

Power 1000  
2 - channel

The Phase Warp is a variable control used to adjust the phase of the output signal relative to the phase of the input signal. This "phase alignment" is most noticeable when used with an array of woofers whose vertical or horizontal planes are staggered (not emanating from the same point.) Adjusting the Phase Warp can electrically realign the signal fed to each woofer as if all woofers were aligned on a common ZDP. In SPL systems, a desired ZDP (Zero Delay Plane) is the point source where all speaker's voice coils are aligned on the same imaginary plane, thus allowing the signals to arrive at the microphone at the same time.

The phase warp is most noticeable when the system is playing a sine wave (test tone), not music. When used with the proper test equipment, this feature can increase the relative SPL in a system.

If the Phase Warp is not used (like with a competitive SPL vehicle,) each amplifier's Phase Warp should be set to (0°) or (-).

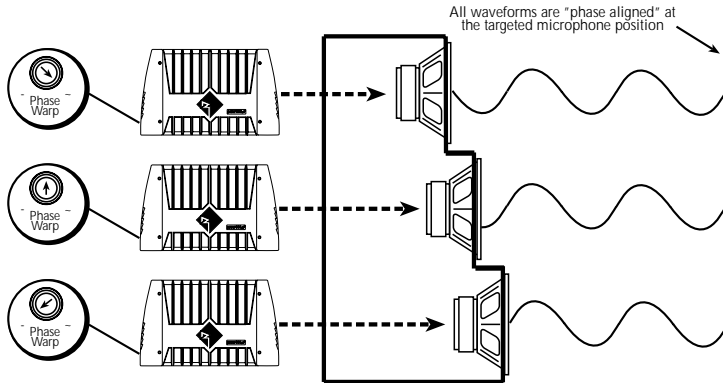

- - **Phase Warp** enables the sine wave to remain unchanged
- ~ **Phase Warp** delays the sine wave in order to "adjust phase"
- Amount of Phase Warp depends upon frequency being played

# SYSTEM DIAGRAMS

## 400 Watt 3-Way System

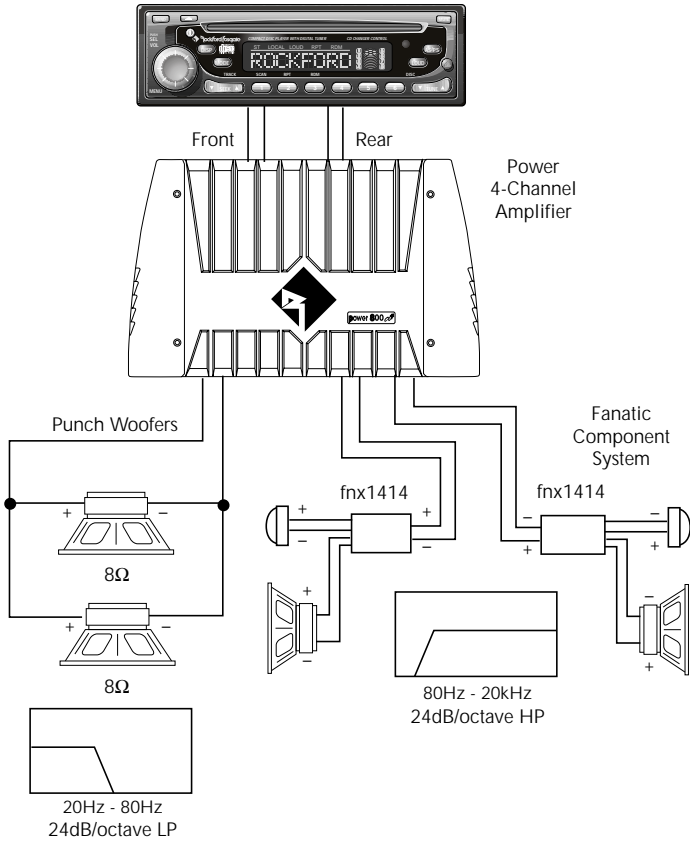

# 650 Watt 4-Way System

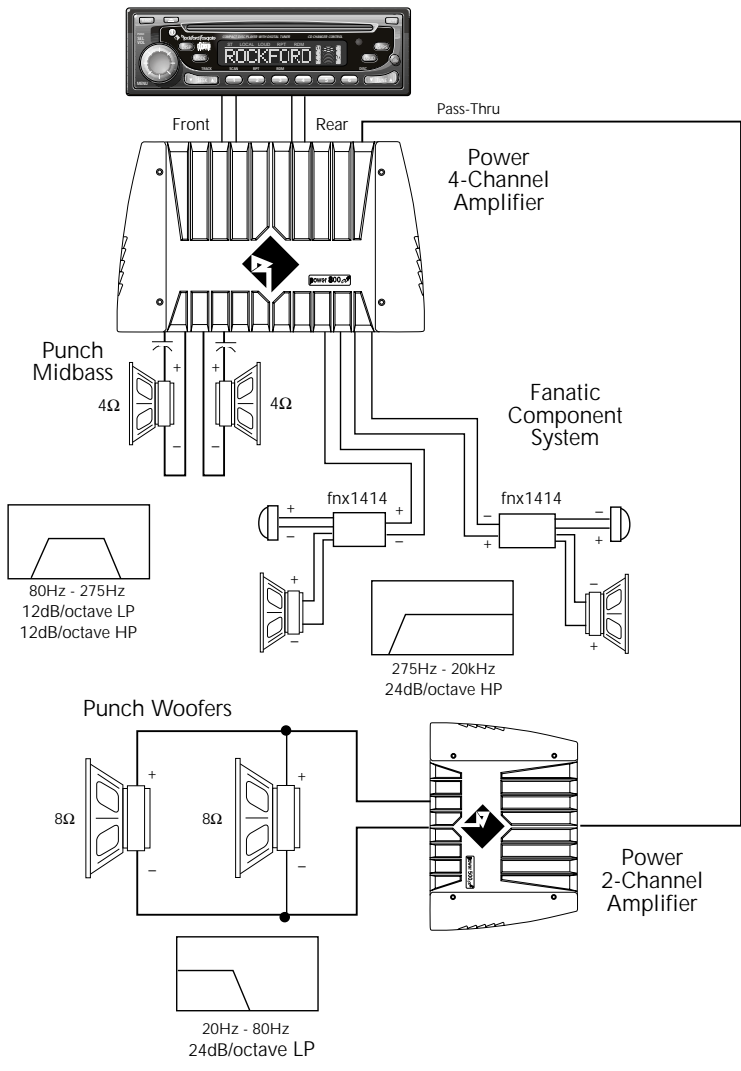

# 1050 Watt 4-Way System

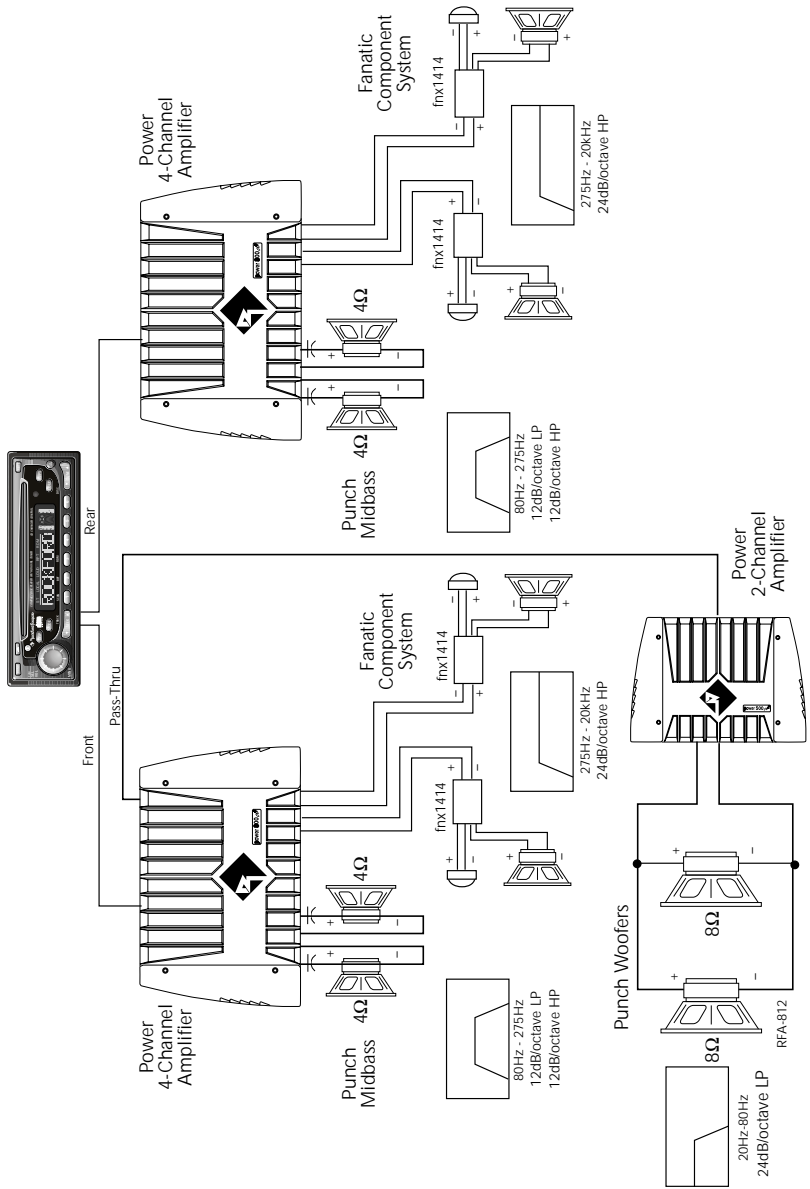

# 1300 Watt 4-Way System

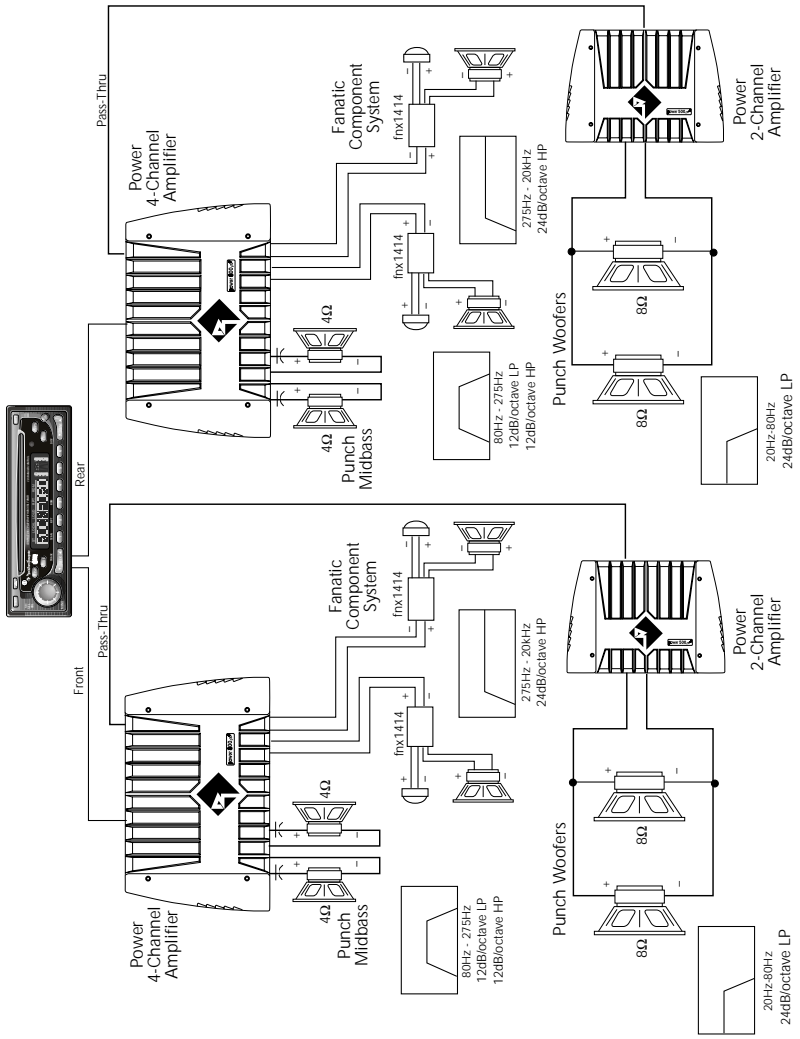





Symptom	Diagnosis	Remedy
<b>Amplifier does not turn on</b> (Power LED is off)	Voltage applied to the REM terminal of the amplifier is not between 10.5 and 15.5 volts or there is no voltage present.	Check the alternator, battery, fuse, and wiring and repair as necessary. If the voltage is above 15.5 volts, have the electrical system inspected by an authorized car service center.
	Voltage to the B+ terminal of the amplifier is not between 10.5 and 15.5 volts or there is no voltage present.	Check the alternator, battery, fuse, and wiring and repair as necessary. If the voltage is above 15.5 volts, have the electrical system inspected by an authorized car service center.
	Amplifier is not properly grounded.	Check wiring and repair as necessary.
<b>Amplifier has no sound</b> (Power LED is on)	RCA Input from source unit is not connected or not functioning properly.	Check connections, substitute with known working source and cables and repair or replace as necessary.
	Speaker leads are shorted to each other or to the chassis of the vehicle.	Disconnect existing speakers and test with known working speakers and wires. If amplifier plays, check and repair wiring and installation of speakers as necessary.
	Speakers are defective.	Disconnect existing speakers and test with known working speakers. If amplifier plays, check and repair speakers as necessary.



Symptom	Diagnosis	Remedy
<b>Speaker Output Low or Distorted</b>	Input gain signal for amplifier is incorrectly set.	Readjust input gains of amplifier.
	Source unit output too low or source unit has no output.	Check system with known working source and repair or replace original source as needed.
	Low battery voltage or large voltage drops to the amplifier under load.	Check the alternator, battery, fuse, and power and ground wiring. Repair as necessary.
<b>Amplifier Noise (Turn-on Pop)</b>	Voltage spike from output of preceding component is entering amplifier through input signal.	Disconnect input signal to amplifier and turn amplifier on and off. If noise is eliminated, connect REM lead of amplifier to source unit with a delay turn-on module.
	Voltage spike from remote turn-on lead is entering through REM input terminal.	Use a different 12 volt source for REM lead of amplifier (i.e., battery direct). If noise is eliminated, use a relay to isolate amplifier from noisy turn-on output.



Symptom	Diagnosis	Remedy
<b>Engine Noise</b>	Noise is radiating into RCA signal cable.	Check connections, run the RCA cables on a different route away from sources of high current.
	Bad component in the signal chain.	Check connections, bypass additional components (cross-overs and equalizers) between the source unit and the amplifier. Connect one component at a time to determine the culprit. Repair or replace components as necessary.
	Noise is radiating into speaker cables.	Disconnect existing speakers and connect a test speaker to the output terminals of the amplifier. If noise is gone, re-route the speaker cables away from sources of high voltage.
	Multiple grounds in the audio system.	Check ground connections and connect amplifiers, signal processors, and other components to a central location or try a different grounding point on the chassis.
	Ground loop between source unit and antenna.	Check connections, disconnect antenna from source unit. If noise is gone, install an antenna ground loop isolator.
<b>Engine Noise when using high level inputs</b>	TOPAZ input circuitry (in Rockford amps) or floating input circuitry (in non-Rockford amps) does not have reference to "chassis ground." This noise, if any, occurs at the auxiliary amplifier whose inputs are fed from the pass-thru output of the first amp.	Supply reference ground to the TOPAZ input circuit (or floating input circuit in non-Rockford amps). Connect shield of RCA input from auxiliary amp to chassis ground of radio. An alternative method is to connect the RCA shield to the amplifier's power ground terminal.

• If noise persists, see your Authorized Rockford Fosgate Dealer.

# **DYNAMIC POWER MEASUREMENTS**

---

## **About the Dynamic Power Measurements**

The Audio Graph PowerCube is a test instrument used to measure the output of an amplifier in accordance with IHF-202 industry standards. The IHF-202 standard is a dynamic power measurement and was developed as a means of measuring power in a manner that best represents the Real World operation of an amplifier. Many manufacturers, including Rockford Fosgate, at times will measure amplifier power into a fixed resistor (4 ohm, 2 ohm). While this method is useful in some types of evaluation and testing, it is not representative of an amplifier that is connected to a speaker and playing music.

## **Music**

Music is dynamic; the sound waves are complex and constantly changing. In order to simulate this, the IHF-202 standard calls for the input signal to the amplifier to be a 1kHz burst tone. This signal is input (on for 20 milliseconds) and reduced 20dB for 480 milliseconds. The signal is gradually increased in level until the amplifier's output exceeds 1% Total Harmonic Distortion (THD). At 1% distortion becomes audible, therefore, any power produced above that level is considered *unusable*. Many manufacturers represent their amplifiers' output power in excess of 10% distortion. They use many names for this measurement, such as Total Maximum Power or Maximum Output Power. This is not indicative of the *actual usable output power*.

## **Listening to Loudspeakers - Not Resistors**

A loudspeaker is not a resistor. A resistor's value (resistance measured in ohms) is fixed. A loudspeaker's impedance is dynamic. It is constantly changing in value, dependent upon the frequency of the input signal. Therefore, measuring power with the amplifier loaded into a 4 ohm resistor is not the same as measuring power with the amplifier connected to a 4 ohm speaker. Most people do not listen to music through a resistor.

A 4 ohm speaker may experience a drop in impedance 4-6 times lower than its nominal (printed) impedance. A speaker will also create phase shifts in the signal that is passed through it. These phase shifts happen because a speaker is an inductor (voice coil) and a capacitor (compliance of the surround/spider), as well as a resistor (voice coil wire).

To simulate a speaker the Audio Graph PowerCube measures output power into 20 different loads. It tests at 8 ohms, 4 ohms, 2 ohms and 1 ohm. Each of these impedances is also tested at  $-60^\circ$ ,  $-30^\circ$ ,  $0^\circ$ ,  $+30^\circ$  and  $+60^\circ$  phase angles. These different impedances and phase angles represent the shifts in impedance and phase that can occur in a typical loudspeaker.

## Information Cubed

The data acquired in the testing procedure is then graphed in the form of a 3-dimensional cube, hence the name **PowerCube**.

The *Phase Angle* is expressed on the horizontal axis, the *Output Voltage* is presented on the vertical axis and the *Impedance* is displayed on the Z axis. *Output Power*, in watts, is listed on the left hand side for each impedance at each phase angle.

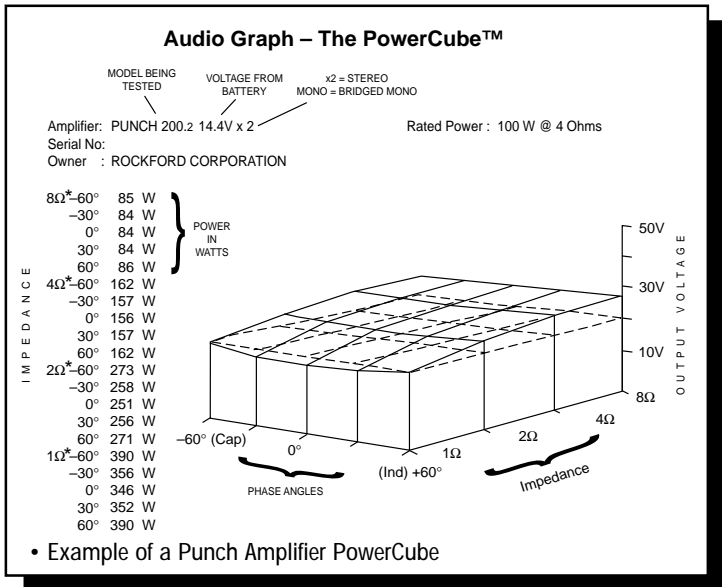

## What is an Amplifier?

An amplifier by definition is a voltage generating device, recreating the signal which is input to it identically but with increased volume. It will be connected to a reactive load (the speaker). The impedance of this load and phase of the signal passing through the load will vary, dependent upon the frequency of the input signal (music).

Therefore, a perfect amplifier will be able to maintain the same output voltage regardless of load characteristics and will not alter the signal it is reproducing. A perfect amplifier when measured by the Audio Graph PowerCube would present data that forms a perfect cube. Unfortunately, amplifiers are not perfect. The laws of physics generally prevent it. A great amplifier is about the best one can hope to attain.

As you can see by the PowerCube and as you will experience by listening, your Punch amplifier is a GREAT AMPLIFIER!

# LIMITED WARRANTY INFORMATION

---

Rockford Corporation offers a limited warranty on Rockford Fosgate products on the following terms:

- **Length of Warranty**

3 years on electronics	90 days on electronic B-stock (receipt required)
2 years on source units	90 days on speaker B-stock (receipt required)
1 year on speakers	
  
- **What is Covered**

This warranty applies only to Rockford Fosgate products sold to consumers by Authorized Rockford Fosgate Dealers in the United States of America or its possessions. Product purchased by consumers from an Authorized Rockford Fosgate Dealer in another country are covered only by that country's Distributor and not by Rockford Corporation.
  
- **Who is Covered**

This warranty covers only the original purchaser of Rockford product purchased from an Authorized Rockford Fosgate Dealer in the United States. In order to receive service, the purchaser must provide Rockford with a copy of the receipt stating the customer name, dealer name, product purchased and date of purchase.
  
- **Products found to be defective during the warranty period will be repaired or replaced (with a product deemed to be equivalent) at Rockford's discretion.**
  
- **What is Not Covered**
  1. Damage caused by accident, abuse, improper operations, water, theft
  2. Any cost or expense related to the removal or reinstallation of product
  3. Service performed by anyone other than Rockford or an Authorized Rockford Fosgate Service Center
  4. Any product which has had the serial number defaced, altered, or removed
  5. Subsequent damage to other components
  6. Any product purchased outside the U.S.
  7. Any product not purchased from an Authorized Rockford Fosgate Dealer
  
- **Limit on Implied Warranties**

Any implied warranties including warranties of fitness for use and merchantability are limited in duration to the period of the express warranty set forth above. Some states do not allow limitations on the length of an implied warranty, so this limitation may not apply. No person is authorized to assume for Rockford Fosgate any other liability in connection with the sale of the product.
  
- **How to Obtain Service**

Please call 1-800-669-9899 for Rockford Customer Service. You must obtain an RA# (Return Authorization number) to return any product to Rockford Fosgate. You are responsible for shipment of product to Rockford.

Ship to: **Electronics**  
Rockford Corporation  
Warranty Repair Department  
2055 E. 5th Street  
Tempe, AZ 85281  
RA#: \_\_\_\_\_

Ship to: **Speakers**  
Rockford Acoustic Design  
(Receiving-speakers)  
609 Myrtle N.W.  
Grand Rapids, MI 49504  
RA#: \_\_\_\_\_



**LEA DETENIDAMENTE LAS SIGUIENTES INSTRUCCIONES DE INSTALACION DEL PRODUCTO. EVITARA POSIBLES DAÑOS A VD., AL VEHICULO O AL PRODUCTO.**

## **INTRODUCCION**

---

Los ingenieros de Rockford han diseñado los amplificadores Power para ofrecer en el difícil entorno de un automóvil una calidad de sonido superior en un producto flexible, fiable y eficiente. Trans•ana/Trans•nova es un circuito de baja tensión en la etapa de preamplificación de los amplificadores Power que permite que la musica suene limpia y cristalina y muy real, incluso a altos niveles de audicion. Esto se complementa con el TOPAZ, un circuito exclusivo de masa utilizado para eliminar los ruidos asociados con las instalaciones de car-audio. La fiabilidad se refuerza con el uso de un circuito de proteccion llamado NOMAD, mientras que los MOSFET y la tecnologia DSM (montaje discreto en superficie) aumentan la eficiencia del amplificador. La combinacion de todos estos componentes dan al amplificador Power una impresionante calidad de sonido en un chasis discreto.

## **UBICACIÓN PARA EL MONTAJE**

---

### **Montaje en el Malatero**

Monte el amplificador verticalmente con las lineas del radiador orientadas de arriba hacia abajo. De esta manera conseguira la mejor ventilacion.

### **Montaje en el Compartimento de Pasajeros**

El montaje en el compartimento de pasajeros sera eficiente en funcion de la ventilacion que tenga el amplificador. Si va a instalar el amplificador bajo un asiento debera dejar al menos 2.5cm libres sobre la carcasa del amplificador.

### **Instalacion**

Por seguridad, desconecte el terminal negativo de la bateria antes de comenzar la instalacion.

### **Terminal B+**

El cable B+ debe ir provisto de un fusible a una distancia no mayor de 45cm de la bateria. Prepare el cable e instale el portafusibles en el compartimento del motor. Las conexiones han de ser impermeables.

### **Terminal GND**

Prepare un trozo de cable para usarlo como toma de masa. Prepare un punto de masa en el chasis rascando y eliminando la pintura de la superficie de metal y limpielo de toda suciedad asegure el cable al chasis con un tornillo.



## Terminal REM

Conecte el cable REM a un punto de +12V con mutable. La señal se suele coger de la salida auto antenna del radio cassette si este no tiene salida remote.

### Funcionamiento Estereo/Mono

Power 360    Power 500  
2 - canales    2 - canales

Power 800    Power 1000  
2 - canales    2 - canales

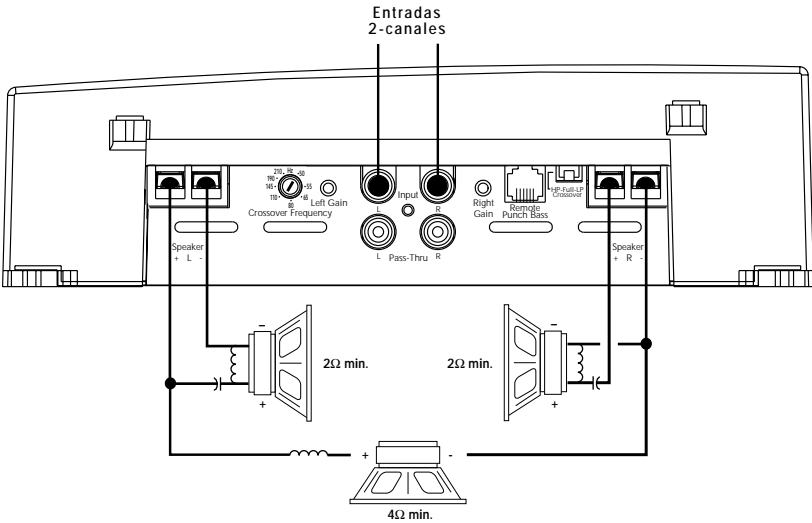

# Funcionamiento Estereo

**Power 400**    **Power 800**  
 4 - canales    4 - canales

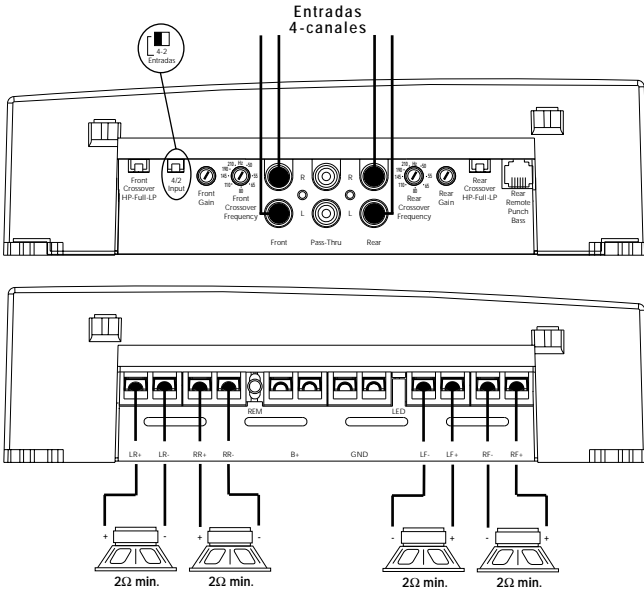

**ATTENTION:** Veuillez lire les instructions suivantes pour l'installation de cet amplificateur. Ne pas les suivre pourrait causer des blessures ou endommager le véhicule.

## INTRODUCTION

---

Les ingénieurs de Rockford Fosgate ont conçu l'amplificateur Power pour supporter l'environnement rude de l'automobile en délivrant une qualité de son supérieure dans un ensemble efficace, fiable et flexible. Trans•ana/Trans•nova est un circuit de bas voltage dans l'étage de préamplification de tous les amplificateurs Punch qui reproduit un son musical clair comme du cristal et très réel, même à très haut volume. Ceci est accompagné du TOPAZ, un circuit unique employé pour éliminer les problèmes de bruits parasites associés aux systèmes audiomobile et leur installation.

La fiabilité est garantie grâce au circuit de protection NOMAD, la technologie MOSFET et DSM (Composants Montés en Surface) améliorent l'efficacité de l'amplificateur.

L'ensemble de ces atouts donne à l'amplificateur Power une qualité de son inégalable sous une carrosserie "pare-balles."

FRANÇAIS

## MONTAGE

---

### Montage dans le coffre

Monter l'amplificateur verticalement avec les rainures de haut en bas ce qui lui permet de refroidir plus facilement.

### Montage dans l'habitacle

Monter l'amplificateur dans l'habitacle ne pose aucun problème, du moment qu'il y ait assez d'air pour le refroidir. Si vous montez l'ampli en dessous du siège, prévoyez 2.5 cm d'air autour du radiateur.

### Installation

Pour votre sécurité, déconnectez la borne négative de la batterie du véhicule avant de commencer l'installation.

### Terminal B+

Il est impératif qu'il y ait un fusible sur le câble pour la connexion à la masse. Préparez le châssis en grattant la peinture de la surface métallique et nettoyez la saleté et l'huile. Attachez le câble au châssis avec une vis.

### Terminal GND

Préparez une longueur de câble pour la connexion à la masse. Préparez le châssis en grattant la peinture de la surface métallique et nettoyez la saleté et l'huile. Attachez le câble au châssis avec une vis.

### Terminal REM

Connectez le fil REM à une commande 12 volts positive de la source. La commande 12 volts est habituellement prise sur la sortie antenne électrique de la source ou la commande accessoire. Si la source ne dispose pas de ces sorties, nous vous recommandons d'installer un interrupteur qui fournira un positif 12 volts au REM de l'amplificateur.

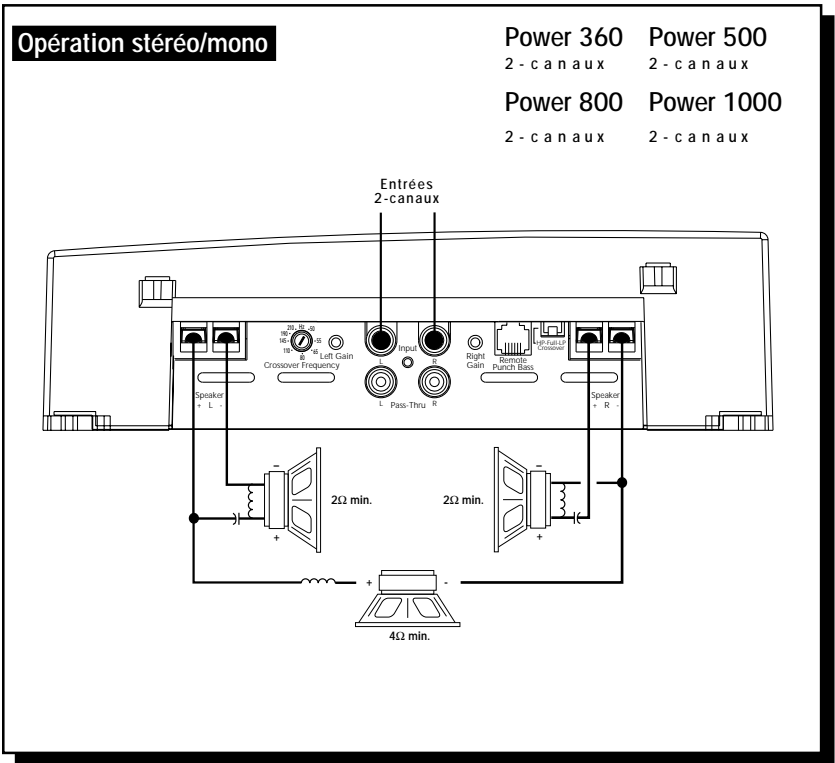

# Opération stéréo

Power 400    Power 800  
4 - canaux    4 - canaux

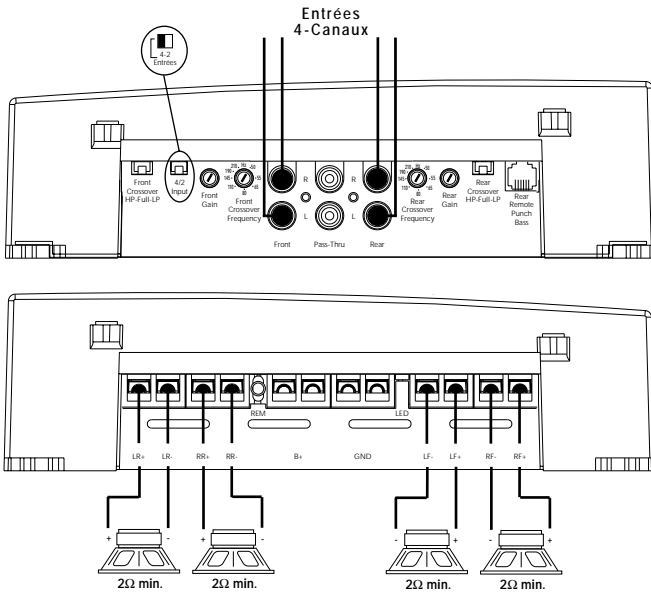

**BITTE LESEN SIE DIESE GEBRAUCHSANLEITUNG ZUERST SORGFÄLTIG DURCH. DAS KANN SIE VOR DEM FALSCHEN EINSATZ, AUSFALLEN ODER SOGAR BESCHÄDIGUNG DES PRODUKTES ODER IHRES FAHRZEUGES SCHÜTZEN.**

## **EINLEITUNG**

---

Rockford Ingenieure haben die Power Verstärker entwickelt. Mit höchstem Technologie-Standart, hervorragender Klangqualität, einfacher Handhabung und bester Servicefreundlichkeit Trans•ana/Trans•nova ist eine Nieder-Volt Schaltung im Vorverstärkerteil aller Pünch Verstärker die für kristallklaren Klang auch bei sehr hohen Lautstärken sorgt. TOPAZ, eine einzigartige Erdungsschaltung verhindert und unterdrückt Einstreuungen und Störungen die nur allzu oft Car Audio Systeme beeinträchtigen. Flexibilität durch die Vielfalt der Aktivweiche mit ihren Lebensdauer durch die Schutzschaltung NOMAD und der Einsatz von MOSFET Transistoren und DSM (Discrete Surface Mount), machen diese Verstärker so effizient. Das Ergebnis all dieser Komponenten machen Power-Verstärker so einzigartig und in ihrer Klangqualität nahezu unschlagbar.

## **EINBAUORT**

---

### **Im Fahrzeugkofferraum**

Der vertikale Einbau der Endstufen, das bedeutet, daß die Kühlrippen von oben nach unten verlaufen, gibt dem Verstärker die beste Kühlung.

### **Auf der Beifahrerseite**

Sollte der Verstärker auf der Beifahrerseite montiert werden, so ist es sehr wichtig, für eine ausreichende Kühlung zu sorgen. Sollte der Verstärker z.B. unter dem Beifahrersitz montiert werden, sollte dem Kühlkörper mindestens ein Luftspalt von 2.5 cm bleiben, um so für eine ausreichende Kühlung zu sorgen.

### **Einbau**

Zur Sicherheit klemmen Sie den Negativ-Pol der Batterie während des gesamten Einbaues ab.

### **B+ Anschluß**

Die Plus-Leitung MUß ca. 45 cm nach dem Plus-Pol der Batterie abgesichert sein. Preparieren Si die Kabellängen und montieren Sie den Sicherungshalter im Motorraum. ALLE Verbindungen müssen wasserdicht sein.

## GND Anschluß

Preparieren Sie Ihr Kabel für die Negativ Leitung (Erdung). Preparieren Sie die Anschlußstelle des Erdungskabels, indem Sie das Metall gründlich reinigen und vom Lack befreien. Befestigen Sie nun die Erdung an dieser Stelle mit einer Schraube.

## REM Anschluß

Verbinden Sie das Ein- und Ausschaltungskontroll-Kabel mit Ihrem Radio (12 Volt positiv). Normalerweise verwenden Sie hierfür die Ant.-Remote Ihres Radios oder ein eigens dafür vorgesehenes Kabel (Amp-Remote). Sollte Ihr Radio diesen Anschluß nicht besitzen, so verwenden Sie eine 12 Volt Spannung, die Sie durch einen Schalter ein- und ausschalten können.

### Stereo/Mono Operation

Power 360    Power 500  
2 - Kanales    2 - Kanales

Power 800    Power 1000  
2 - Kanales    2 - Kanales

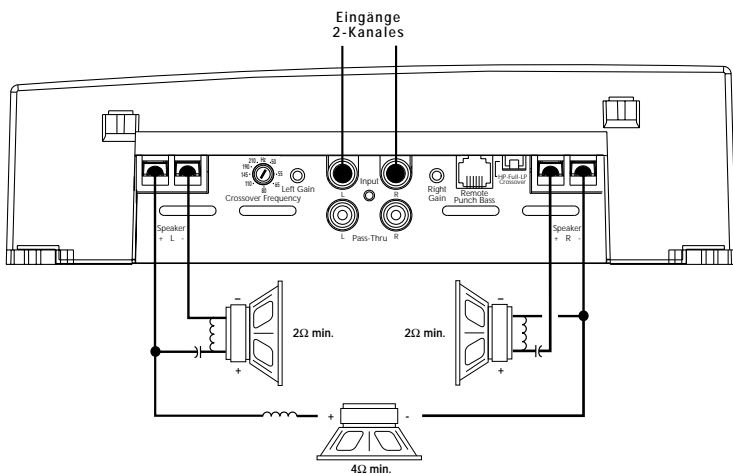

# Stereo Operation

**Power 400**    **Power 800**  
 4 - canales    4 - canales

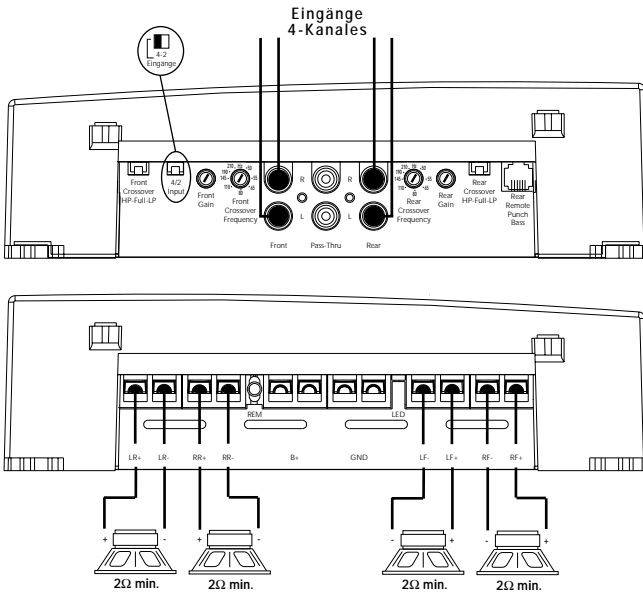



**ATTENZIONE: SI PREGA DI LEGGERE LE SEGUENTI ISTRUZIONI PER L'INSTALLAZIONE DI QUESTO PRODOTTO. IL NON SEGUIRLE POTREBBE RISULTARE SERIAMENTE DANNOSO PER LA PERSONA O PER IL VEICOLO.**

## **INTRODUZIONE**

---

Gli ingegneri Rockford hanno progettato la serie di amplificatori Power per resistere all'ostico ambiente automobilistico mentre suonano con una musicalità superiore, offrendo un insieme versatile, affidabile ed efficiente. Trans•ana/Trans•nova é un circuito a bassa tensione dello stadio preamplificatore del Punch che permette al suono di essere cristallino e reale anche in presenza di volumi molto elevati... tutto questo é accoppiato TOPAZ, un esclusivo circuito di massa impiegato per eliminare i problemi di rumore comunemente presenti negli impianti car audio. L'affidabilità é completamente garantita dall'impiego di un circuito di protezione chiamato NOMAD, mentre l'uso di MOSFET e della tecnologia DSM (Discrete Surface Mount) permette di raggiungere efficienze elevatissime. Il risultato finale di tutte queste tecnologie moderne é che gli amplificatori Power suonano meravigliosamente e sono indistruttibili, a "prova di proiettile."

## **DOVE POSIZIONARLO**

---

### **Nel Bagagliaio**

Montando l'amplificatore su una superficie in verticale con le alette direzionate dall'alto verso il basso si garantirá un miglior raffreddamento dell'amplificatore.

### **Nell'abitacolo**

Montare l'amplificatore nell'abitacolo si avrà un funzionamento regolare se si garantisce un flusso d'aria sufficiente. Per l'installazione sotto un sedile, é necessario avere uno spazio di almeno 2.5 cm attorno a tutto l'amplificatore.

### **Installazione**

Per sicurezza, scollegare il polo negativo della batteria dell'auto prima di iniziare l'installazione.

### **Terminale B+ (cavo positivo)**

Il cavo positivo deve essere protetto da un fusibile a non piú di 45 cm dalla batteria. Terminare il cavo e installare il fusibile nel vano motore. Tutte le connessioni devono essere a prova d'acqua.

### Terminale GND (cavo negativo)

Decidere la lunghezza del cavo e terminarlo. Preparare la massa grattando la vernice dal telaio dell'auto ed eliminando tracce di olio o sporco. Fissare il cavo di massa al telaio con una vite.

### Terminale REM (Consenso di accensione)

Collegare il cavo REM ad un positivo presente solo ad autoradio accesa (normalmente il cavo pilota dell'antenna elettrica o il cavo accessori dell'autoradio). Se la sorgente non dovesse essere equipaggiata con queste uscite, la soluzione raccomandabile é di inserire un interruttore su un cavo positivo e connettersi all'amplificatore.

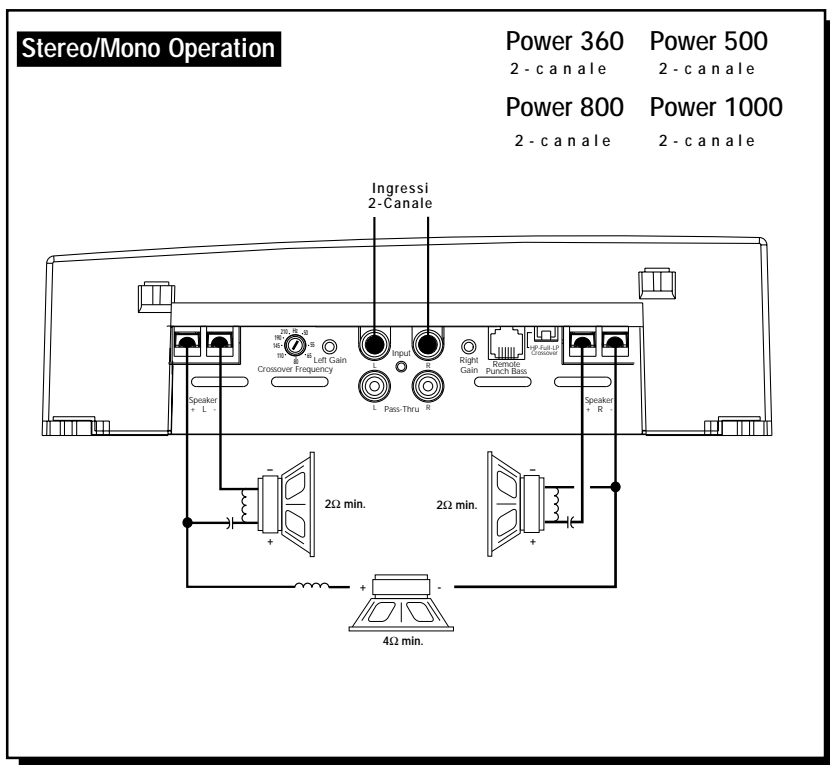

# Stereo Operation

Power 400    Power 800  
4 - canales    4 - canales

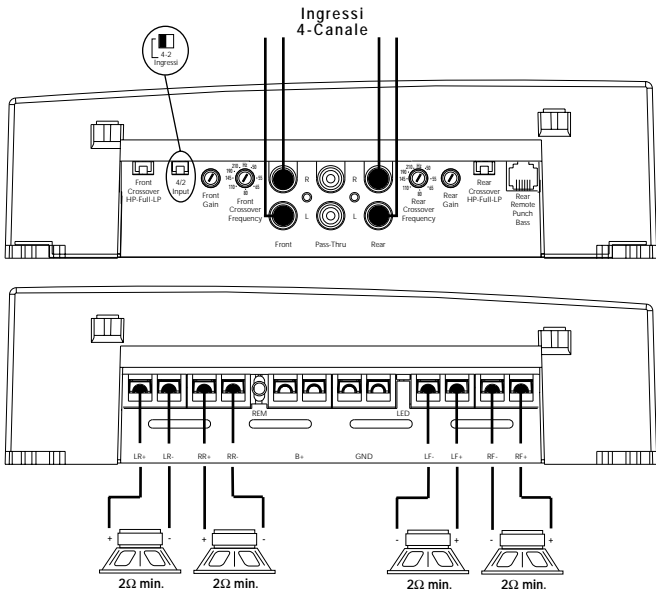

Installation assistance available at:

**RFTECH**

[www.rockfordfosgate.com/rftech](http://www.rockfordfosgate.com/rftech)

**MADE IN THE USA**

This product is designed, developed and assembled in the USA by a dedicated group of American workers. The majority of the components used in the construction of this product are produced by American companies. However, due to the global nature of their manufacturing facilities and the loudspeaker parts industry in general, some parts may be manufactured in other countries.

**Rockford Fosgate**

Rockford Corporation

546 South Rockford Drive

Tempe, Arizona 85281 U.S.A.

In U.S.A., (602) 967-3565

In Europe, Fax (49) 8503-934014

In Japan, Fax (81) 559-79-1265