

power 150
trans·ana

power 200
trans·ana

 **Rockford Fosgate**
car audio for 

mono Amplifiers
operation & installation

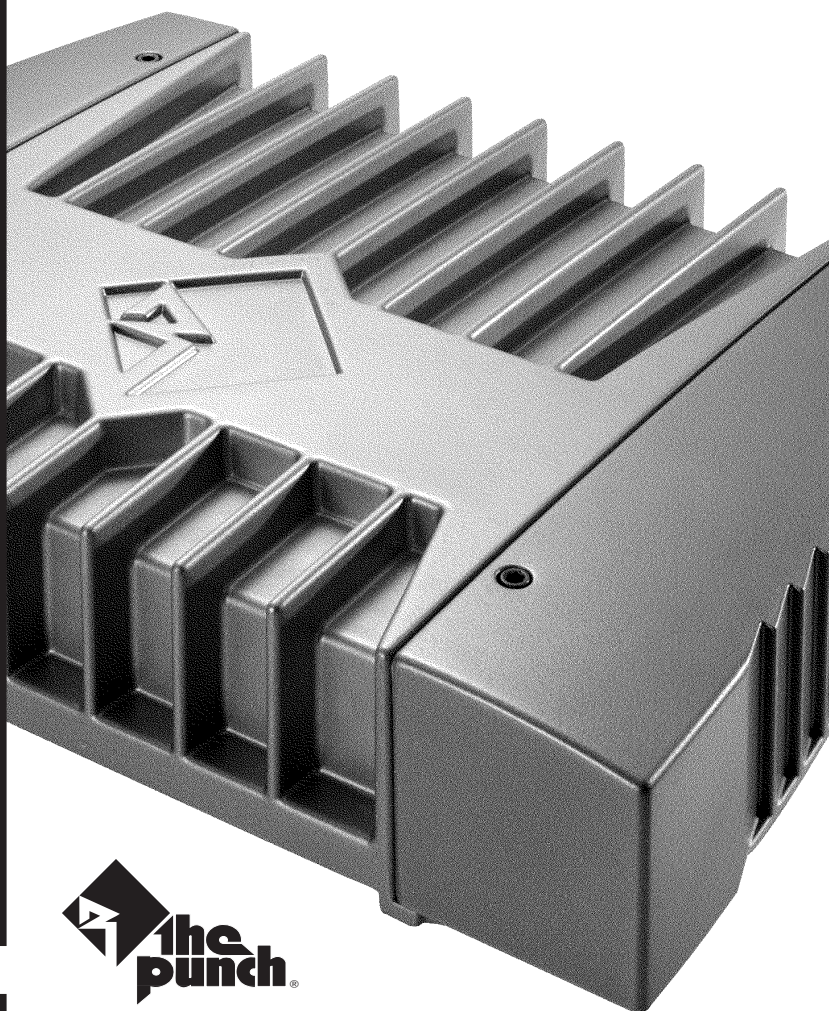

 **the
punch**

power

SPECIFICATIONS

	POWER 150	POWER 200
Dynamic Power Rating (IHF-202 Standard) - Measured at 14.4 Volts		
Mono into a 4Ω Load	110 Watts	150 Watts
Mono into a 2Ω Load	190 Watts	260 Watts
Continuous Power Rating (Competition Standard) - Measured at 13.8 Battery Volts		
RMS continuous power mono , driven into a 4Ω load from 20 to 20,000Hz with less than 0.05% Total Harmonic Distortion (THD)	75 Watts	100 Watts
RMS continuous power mono , driven into a 2Ω load from 20 to 20,000Hz, with less than 0.1% Total Harmonic Distortion (THD)	150 Watts	200 Watts
Signal-to-Noise Ratio	>100dB A-weighted	
Crossover Slope	12dB/octave Butterworth	
Crossover Frequency	variable from 50Hz to 210Hz	
Dimensions	2.60" (6.60cm) H	2.60" (6.60cm) H
	9.60" (24.38cm) W	9.60" (24.38cm) W
	6.70" (17.01cm) L	7.70" (19.55cm) L
Frequency Response	20Hz to 20kHz ±0.5dB	
Bandwidth	10Hz to 200kHz ±3dB	
Damping Factor @ 4Ω (at output connector)	>200	
Slew Rate	30 Volts/μs	
IM Distortion (IHF)	<0.05%	
Source Unit Compatibility (+15dB gain overlap)	17V max. (low level in)	
Input Sensitivity (+0dB gain overlap)	Variable from 250mV to 4V (low level in)	
	Variable from 650mV to 11V (high level in)	
Protection	NOMAD - Internal analog-computer output protection circuitry limits power in case of overload. Thermal switch shuts down the amplifier in case of overheating.	
Battery Fusing Rates (External to Amplifier)	15 amps	20 amps
Fuse Type	ATC	ATC
Equalization (45Hz Punch Bass)	Variable from 0dB to +18dB @ 45Hz	
Input Impedance	20k ohms	

Specifications are subject to change without notice.

Dear Customer,

Congratulations on your purchase of the world's finest brand of car audio amplifiers. At Rockford Fosgate we are fanatics about musical reproduction at its best, and we are pleased you chose our product. Through years of engineering expertise, hand craftsmanship and critical testing procedures, we have created a wide range of products that reproduce music with all the clarity and richness you deserve.

For maximum performance we recommend you have your new Rockford Fosgate product installed by an Authorized Rockford Fosgate Dealer, as we provide specialized training through Rockford Technical Training Institute (RTTI). Please read your warranty and retain your receipt and original carton for possible future use.

Great product and competent installations are only a piece of the puzzle when it comes to your system. Make sure that your installer is using 100% authentic installation accessories from Connecting Punch in your installation. Connecting Punch has everything from RCA cables and speaker wire to Power line and battery connectors. Insist on it! After all, your new system deserves nothing but the best.

To add the finishing touch to your new Rockford Fosgate image order your Rockford wearables, which include everything from T-shirts and jackets to hats and sunglasses.

To get a free brochure on Rockford Fosgate products and Rockford accessories, in the U.S. call 602-967-3565 or FAX 602-967-8132. For all other countries, call +001-602-967-3565 or FAX +001-602-967-8132.

PRACTICE SAFE SOUND™

**CONTINUOUS EXPOSURE TO SOUND PRESSURE LEVELS OVER 100dB
MAY CAUSE PERMANENT HEARING LOSS. HIGH POWERED AUTOSOUND
SYSTEMS MAY PRODUCE SOUND PRESSURE LEVELS WELL OVER
130dB. USE COMMON SENSE AND PRACTICE SAFE SOUND.**

If, after reading your manual, you still have questions regarding this product, we recommend that you see your Rockford Fosgate dealer. If you need further assistance, you can call us direct at 1-800-669-9899. Be sure to have your serial number, model number and date of purchase available when you call.

The serial number can be found on the outside of the box. Please record it in the space provided below as your permanent record. This will serve as verification of your factory warranty and may become useful in recovering your amplifier if it is ever stolen.

Serial Number: _____

Model Number: _____

TABLE OF CONTENTS

Specifications	i
Introduction	1
Amplifier Accessory Pack	1
Feature Chart	2
Design Features	4
Installation Considerations	6
Mounting Location	7
Battery and Charging	8
Wiring the System	8
Using Passive Crossovers	10
Table of Component Values	11
Installation	12
System Diagrams	15
Troubleshooting	18
Dynamic Power Measurements	20
Warranty Information	22
International Information	23

GETTING STARTED

Welcome to Rockford Fosgate! This manual is designed to provide information for the owner, salesperson and installer. For those of you who want quick information on how to install this product, please turn to the **Installation Section** of this manual or refer to the icons listed below. Other information can be located by using the Table of Contents. We, at Rockford Fosgate, have worked very hard to make sure all the information in this manual is current. But, as we are constantly finding new ways to improve our product, this information is subject to change without notice.



Sections marked
ADVANCED OPERATION
include in-depth
technical information



Sections marked
INSTALLATION
include "slam dunk"
wiring connections



Sections marked
TROUBLESHOOTING
include recommendations for
curing installation problems

INTRODUCTION

Rockford engineers designed the Power 150 and Power 200 amplifiers to withstand the rugged automotive environment while delivering superior sound quality in a flexible, reliable, and efficient package. TRANS•ana is a low voltage circuit in the preamp stage lets the music sound crystal clear and very real, even when played at high volume levels. This is matched with TOPAZ, a unique grounding circuit used to eliminate noise problems associated with car audio systems and their installation. Flexibility is accomplished with the use of a built-in variable crossover. The use of a protection circuit called NOMAD, along with MOSFET and DSM (Discrete Surface Mount) technologies improve amplifier efficiency. The result of these components give the Power amplifier awesome sound quality in a “Bullet Proof” package. Explanations of these technologies, most of which are exclusively designed and patented by Rockford, are described in the Technical Design Features.

AMPLIFIER ACCESSORY PACK

The accessory pack included with each amplifier contains the mounting hardware necessary to secure the amp to the vehicle and to attach the end caps to the amplifier.

Installation & Operation Manual

Punch Verification Certificate

- (4) Amplifier mounting screws (#8 x 3/4" Phillips)
- (4) Speaker/Power Connector Set Screws (3/32" Allen)
- (4) Endbell Mounting Screws (9/64" Allen)
- (1) Allen Wrench 9/64"
- (1) Allen Wrench 3/32"
- (1) High Level Input Harness (replacement part #CC-1992)
- (1) ATC Inline Fuseholder
- (1) ATC 15 Amp Fuse (Power 150)
- (1) ATC 20 Amp Fuse (Power 200)

POWER MONO AMPLIFIER FEATURE CHART

	Power 150	Power 200
# of CHANNELS	1	1
RMS Power Mono (4Ω)	75x1	100x1
RMS Power Mono (2Ω)	150x1	200x1
Stable Into:	2Ω	2Ω
CIRCUITRY¹		
TRANS• <i>ana</i> – circuit topology	X	X
TRANS• <i>nova</i> – patented circuit topology ²	-	-
Class-H – high efficiency topology	-	-
MEHSA – heat dissipating technology	-	X
TOPAZ – patented noise eliminating circuitry ³	X	
DSM – discrete surface mount	X	X
MOSFETS – power supply and output devices	X	X
NOMAD – protection circuit	X	X
FEATURES		
Die Cast Heatsink ⁴	X	X
Hi-Level Inputs	X	X
RCA Inputs	X	X
Balanced Inputs	-	-
Input Switches	-	-
Pass-Thru	X	X
Pwr/Spk Screw Terminals	-	-
Pwr/Spk Block Terminals	X	X
4 Gauge Pwr/Gnd	-	-

	Power 150	Power 200
Fixed Punch Bass (0dB/+6dB/+12dB @ 45Hz)	-	-
Variable Punch Bass (0dB ~+18dB @ 45Hz)	x	x
Adjustable Crossover (80Hz fixed)	-	-
Variable Crossover (50Hz ~ 210Hz)	LP/FULL ⁵	LP/FULL ⁵
Crossover Slope (Butterworth)	12dB/octave	12dB/octave
Phase Warp (0°~180°)	-	-
GENERAL		
B+ Fuse Size	15A ATC	20A ATC
Dimensions (H x W x L)	2.60" x 9.60" x 6.70" (6.60cm x 24.38cm x 17.01cm)	2.60" x 9.60" x 7.70" (6.60cm x 24.38cm x 19.55cm)

--INTERNAL USE ONLY--

Heatsink Type	#1	#2
---------------	----	----

¹ Additional information on features, specifications and system designs can be found at: www.rockfordfosgate.com

² Trans•nova is patented under U.S. Patent No. 4,467,288

³ TOPAZ is patented under U.S. Patent No. 5,751,823

⁴ Diecast Heatsink patent pending

⁵ HP = 12dB/octave High-Pass / LP = 12dB/octave Low-Pass / FULL = Full Range

DESIGN FEATURES

Punch 150

Punch 200

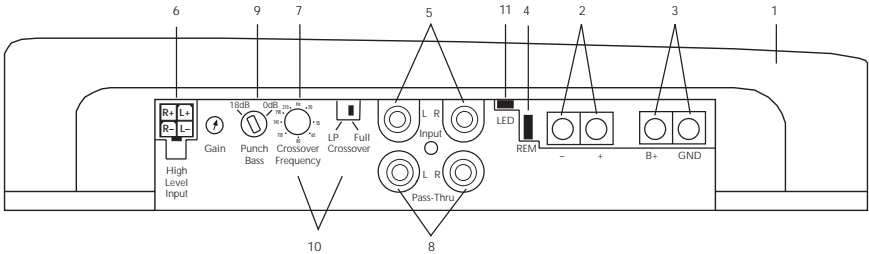

1. **Cast Aluminum Heatsink** – The cast aluminum heatsink of the Punch amplifier dissipates heat generated by the amplifier's circuitry. The inherent advantage of casting provides a 30% improvement of cooling over conventional extrusion heatsink designs.
2. **Speaker Terminals** – The heavy duty, gold-plated terminal block connectors (+ and -) will accept wire sizes from 8 AWG to 18 AWG. These gold-plated connectors are immune to corrosion that can cause signal deterioration.
3. **Power Terminals** – The power and ground connectors on the Punch amplifier are gold-plated and will accommodate up to 8 AWG wire maximizing the input current capability of the amplifier.
4. **REM Terminal** – This spade terminal is used to remotely turn-on and turn-off the amplifier when +12V DC is applied.
5. **RCA Input Jacks** – The industry standard RCA jacks provide an easy connection for signal level input. They are gold-plated to resist the signal degradation caused by corrosion.
6. **High Level Inputs** – The high level inputs use a detachable connector terminated with 20 AWG leads. These inputs should be used if the source unit has only speaker line (high level) outputs.
7. **Gain Control** – The input gain control is preset to match the output of most source units. It can be adjusted to match output levels from a variety of source units.

8. **RCA Pass-Thru Jacks** – The Pass-Thru provides a convenient source for daisy-chaining an additional amplifier without running an extra set of RCA cables from the front of the vehicle to the rear amplifier location.
9. **Punch Bass** – The Punch Bass control helps correct for acoustical deficiencies in the listening environment. The Punch Bass allows a narrow band adjustment at 45Hz to help reproduce full range sound without excessive boost.
10. **Variable Crossover** – The amplifiers have a built-in 12dB/octave Butterworth filter with a crossover point variable from 50Hz to 210Hz. The crossover can be set to Low-Pass (LP) or it can be bypassed by setting it to Full Range (FULL).
11. **LED Power Indicator** – The LED illuminates when the unit is turned on.

INSTALLATION CONSIDERATIONS

The following is a list of tools you will need for installing the amplifier:

Allen wrenches 9/64" & 3/32" (included)	Voltmeter
Wire strippers	Battery post wrench
Electric hand drill w/assorted bits	Wire cutters
17' (5m) Red Power Wire	Assorted connectors
12' (4m) Remote Turn-On Wire	Wire crimpers
1.5' (45cm) Black Grounding Wire	

This section focuses on some of the vehicle considerations for installing your new Punch amplifier. Checking your battery and present sound system, as well as pre-planning your system layout and best wiring routes, will save installation time. When deciding how to lay out your new system, be sure that each component will be easily accessible for making adjustments.

Before beginning any installation, be sure to follow these simple rules:

1. Be sure to carefully read and understand the instructions before attempting to install the amplifier.
2. **For safety**, disconnect the negative lead from the battery prior to beginning the installation.
3. For easier assembly, we suggest you run all wires prior to mounting your amplifier in place.
4. Route all of the RCA cables close together and away from any high current wires.
5. Use high quality connectors for a reliable installation and to minimize signal or power loss.
6. **Think before you drill!** Be careful not to cut or drill into gas tanks, fuel lines, brake or hydraulic lines, vacuum lines or electrical wiring when working on any vehicle.
7. Never run wires underneath the vehicle. Running the wires inside the vehicle provides the best protection.
8. Avoid running wires over or through sharp edges. Use rubber or plastic grommets to protect any wires routed through metal, especially the firewall.
9. **ALWAYS** protect the battery and electrical system from damage with proper fusing. Install a fuseholder and appropriate fuse on the +12V power wire within 18" (46 cm) of the battery terminal.
10. When grounding to the chassis of the vehicle, scrape all paint from the metal to ensure a good, clean ground connection. Grounding connections should be as short as possible and always be connected to metal that is welded to the main body, or chassis, of the vehicle.

MOUNTING LOCATION

The mounting location and position of your amplifier will have a great effect on its ability to dissipate the heat generated during normal operation. The design of our cast aluminum heatsink serves to easily dissipate the heat generated over a wide range of operating conditions. However, to maximize the performance of your amplifier, care should be taken to ensure adequate ventilation.

Trunk Mounting

Mounting the amplifier vertically on a surface with the fin grooves running up and down will provide the best cooling of the amplifier.

Mounting the amplifier on the floor of the trunk will work but provides less cooling capability than vertical mounting.

Mounting the amplifier upside down to the rear deck of the trunk will not provide proper cooling and will severely affect the performance of the amplifier and is strongly *not* recommended.

Passenger Compartment Mounting

Mounting the amplifier in the passenger compartment will work as long as you provide a sufficient amount of air for the amplifier to cool itself. If you are going to mount the amplifier under the seat of the vehicle, you must have at least 1" (2.54cm) of air gap around the amplifier's heatsink.

Mounting the amplifier with less than 1" (2.54cm) of air gap around the amplifier's heatsink in the passenger compartment will not provide proper cooling and will severely affect the performance of the amplifier and is strongly *not* recommended.

Engine Compartment Mounting

Rockford Fosgate amplifiers should *never* be mounted in the engine compartment. Not only will this void your warranty but could create an embarrassing situation caused by the ridicule from your friends.

BATTERY AND CHARGING

Amplifiers will put an increased load on the vehicle's battery and charging system. We recommend checking your alternator and battery condition to ensure that the electrical system has enough capacity to handle the increased load of your stereo system. Stock electrical systems which are in good condition should be able to handle the extra load of any Rockford amplifier without problems, although battery and alternator life can be reduced slightly. To maximize the performance of your Rockford Fosgate amplifier, we suggest the use of a heavy duty battery and an energy storage capacitor.

WIRING THE SYSTEM

CAUTION: *Avoid running power wires near the low level input cables, antenna, power leads, sensitive equipment or harnesses. The power wires carry substantial current and could induce noise into the audio system.*

- **For safety**, disconnect the negative lead from the battery prior to beginning the installation.
1. Plan the wire routing. Take care when running signal level RCA cables to keep them close together but isolated from the amplifier's power cables and any high power auto accessories, especially electric motors. This is done to prevent coupling the noise from radiated electrical fields into the audio signal. When feeding the wires through the firewall or any metal barrier, protect them with plastic or rubber grommets to prevent short circuits. Leave the wires long at this point to adjust for a precise fit at a later time.
 2. Prepare the **Power** cable for attachment to the amplifier by stripping 1/2" of insulation from the end of the wire. Insert the bared wire into the B+ terminal and tighten the set screw to secure the cable in place.

NOTE: *The B+ cable MUST be fused 18" or less from the vehicle's battery. Install the fuseholder under the hood and prepare the cable ends as stated above. Connections should be water tight.*

Trim the power cable within 18" of the battery and strip 1/2" of insulation from the end of the wire. **Cut the wire loop that is attached to the fuseholder in half and splice the fuse into the power line using appropriate inline connectors.** Use the section of cable that was trimmed earlier and connect it to the other end of the fuseholder.

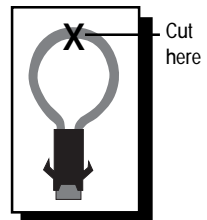

3. Strip 1/2" from the battery end of the power cable and crimp a large ring terminal to the cable. Use the ring terminal to connect to the battery positive terminal. **Do not install the fuse at this time.**
4. Prepare the **Ground** cable for attachment to the amplifier by stripping 1/2" of insulation from the end of the wire. Insert the bared wire into the GND terminal and tighten the set screw to secure the cable in place. Prepare the chassis ground by scraping any paint from the metal surface and thoroughly clean the area of all dirt and grease. Strip the other end of the wire and attach a ring connector. Fasten the cable to the chassis using a non-anodized screw and a star washer.
5. Prepare the **REM** turn-on wire for connection to the amplifier by stripping 1/2" of insulation from the wire end. Insert the bared wire into the REM terminal and tighten the set screw to secure the cable into place. Connect the other end of the REM wire to a switched 12 volt positive source. The switched voltage is usually taken from the source unit's auto antenna or the accessory lead. If the source unit does not have these outputs available, the recommended solution is to wire a mechanical switch in line with a 12 volt source to activate the amplifier.
6. Securely mount the amplifier to the vehicle or amp rack. Be careful not to mount the amplifier on cardboard or plastic panels. Doing so may enable the screws to pull out from the panel due to road vibration or sudden vehicle stops.
7. Connect the source signal to the amplifier by plugging the RCA cables/high level inputs into the input jacks at the amplifier.
8. Connect the speakers. Strip the speaker wires 1/2" and insert into the speaker terminal and tighten the set screw to secure into place. Be sure to maintain proper speaker polarity. ***DO NOT chassis ground any of the speaker leads as unstable operation may result.***
9. Perform a final check of the completed system wiring to ensure that all connections are accurate. Check all power and ground connections for frayed wires and loose connections which could cause problems.

USING PASSIVE CROSSOVERS



A passive crossover is a circuit that uses capacitors and/or coils and is placed on speaker leads between the amplifier and speaker. The crossover delegates a specific range of frequencies to the speaker for optimum driver performance. A crossover network can perform one of three functions: High-Pass (capacitors), Low-Pass (inductors or coils) and Bandpass (combination of capacitor and coil).

The most commonly used passive crossover networks are 6dB/octave systems. These are easy to construct and require one component per filter. Placing this filter in series with the circuit will reduce power to the speaker by 6dB/octave above or below the crossover point depending on whether it is a high-pass or low-pass filter. More complex systems such as 12dB/octave or 18dB/octave can cause impedance problems if not professionally designed.

Passive crossovers are directly dependent upon the speaker's impedance and component value for accuracy. When passive crossover components are used in multiple speaker systems, the crossover's effect on the overall impedance should be taken into consideration along with the speaker's impedance when determining amplifier loads. ***CAUTION: The Power amplifiers are not recommended for impedance loads below 2Ω .***

TABLE OF CROSSOVER COMPONENT VALUES

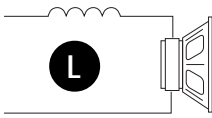

6dB/Octave Low-Pass

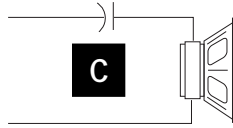

6dB/Octave High-Pass

Freq. Hertz	Speaker Impedance					
	2 OHMS		4 OHMS		8 OHMS	
	L	C	L	C	L	C
80	4.1mH	1000 μ F	8.2mH	500 μ F	16mH	250 μ F
100	3.1mH	800 μ F	6.2mH	400 μ F	12mH	200 μ F
130	2.4mH	600 μ F	4.7mH	300 μ F	10mH	150 μ F
200	1.6mH	400 μ F	3.3mH	200 μ F	6.8mH	100 μ F
260	1.2mH	300 μ F	2.4mH	150 μ F	4.7mH	75 μ F
400	.8mH	200 μ F	1.6mH	100 μ F	3.3mH	50 μ F
600	.5mH	136 μ F	1.0mH	68 μ F	2.0mH	33 μ F
800	.41mH	100 μ F	.82mH	50 μ F	1.6mH	26 μ F
1000	.31mH	78 μ F	.62mH	39 μ F	1.2mH	20 μ F
1200	.25mH	66 μ F	.51mH	33 μ F	1.0mH	16 μ F
1800	.16mH	44 μ F	.33mH	22 μ F	.68mH	10 μ F
4000	.08mH	20 μ F	.16mH	10 μ F	.33mH	5 μ F
6000	51 μ H	14 μ F	.10mH	6.8 μ F	.20mH	3.3 μ F
9000	34 μ H	9.5 μ F	68 μ H	4.7 μ F	.15mH	2.2 μ F
12000	25 μ H	6.6 μ F	51 μ H	3.3 μ F	100 μ H	1.6 μ F

L = Low-Pass (Inductor)
C = High-Pass (Capacitor)

For more information, see your Authorized Rockford Fosgate Dealer.



INSTALLATION

Power Connections

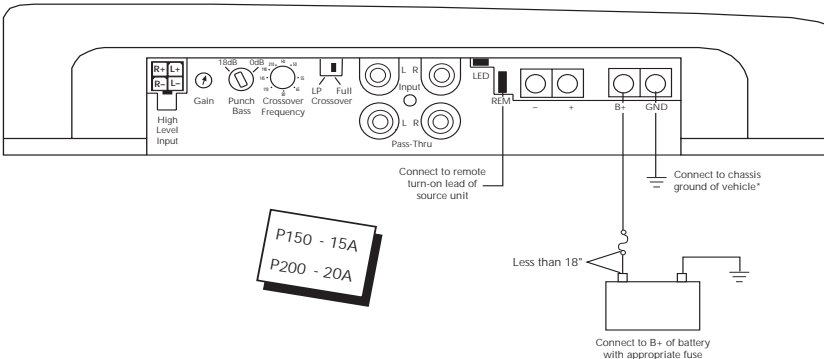

*Keep grounds as short as possible

RCA Inputs High Level Inputs

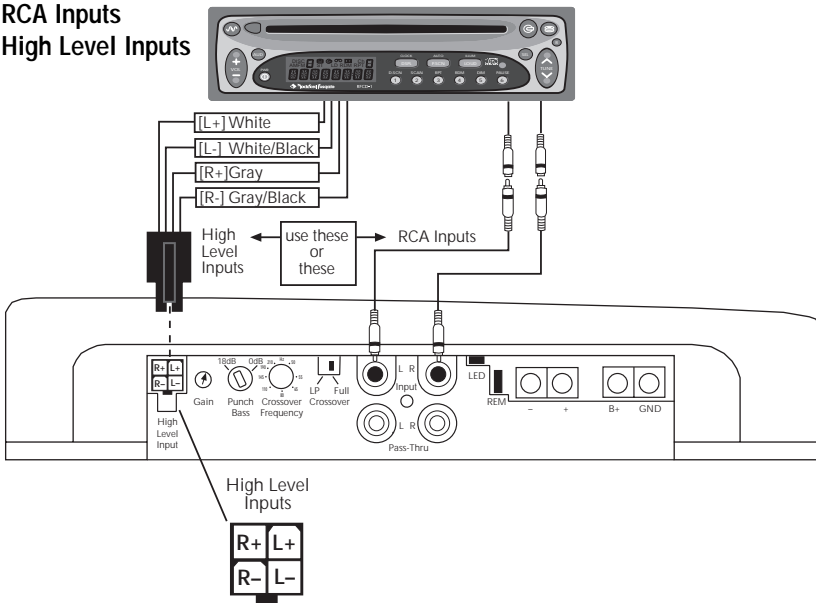

- High Level Inputs connect directly to radio's speaker outputs
 - RCA Inputs connect to radio's RCA preamp outputs
- CAUTION:** Use only one input configuration. Using both the High Level Inputs & RCA Inputs may cause undesirable operation.



Crossover Operation

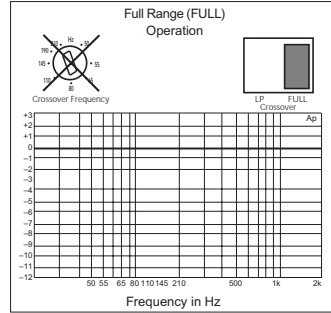
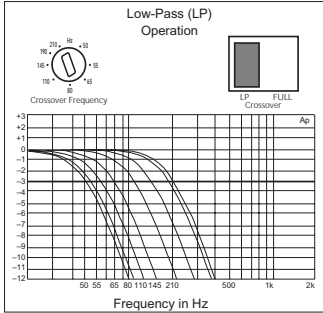
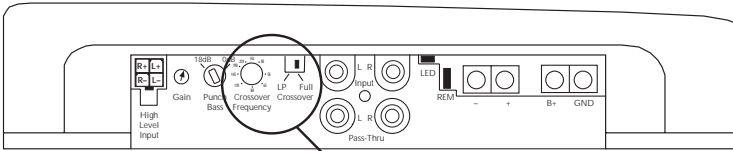

Punch Bass Operation

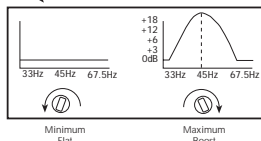
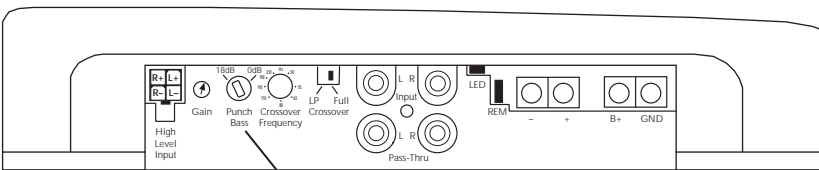

- Carefully increase potentiometer to add Punch to your bass frequencies
- Exercise caution when increasing Punch Bass. Maximum boost can cause potential woofer damage caused by overexcursion



Mono Operation

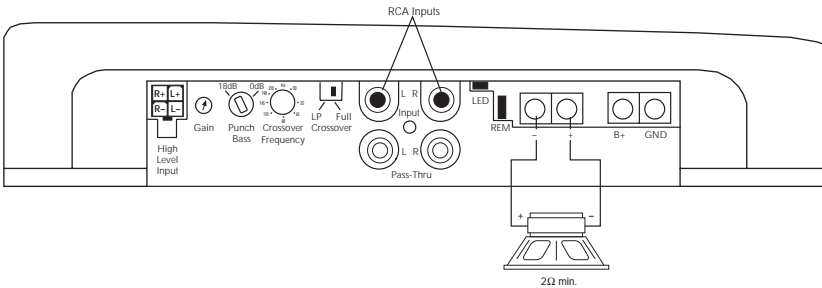

- **RCA inputs** are connected to *both left and right* inputs
- **Speaker Impedance** should be *2Ω minimum*
- **Variable Crossover** can be set for Full Range (FULL) or Low-Pass (LP) adjusted between 50Hz and 210Hz

Pass-Thru

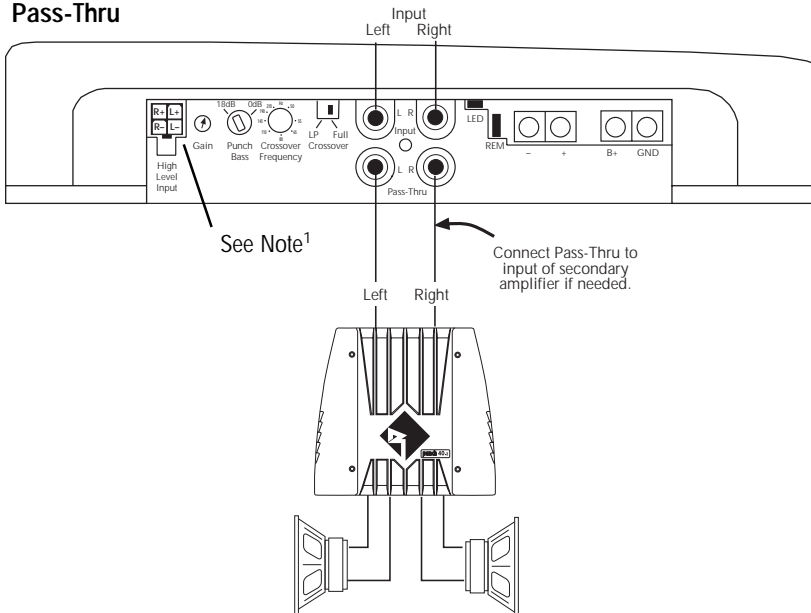

- **Pass-Thru** feeds signal to secondary amplifier
- **Signal from Pass-Thru** remains stereo

Note¹: If using High Level Inputs causes engine whine in an amplifier connected to the Pass-Thru, the Pass-Thru amplifier should have its RCA input shield connected to the radio chassis ground. Refer to the Troubleshooting section of this manual for more information.

SYSTEM DIAGRAMS

2-Way System using Single Voice Coil woofers

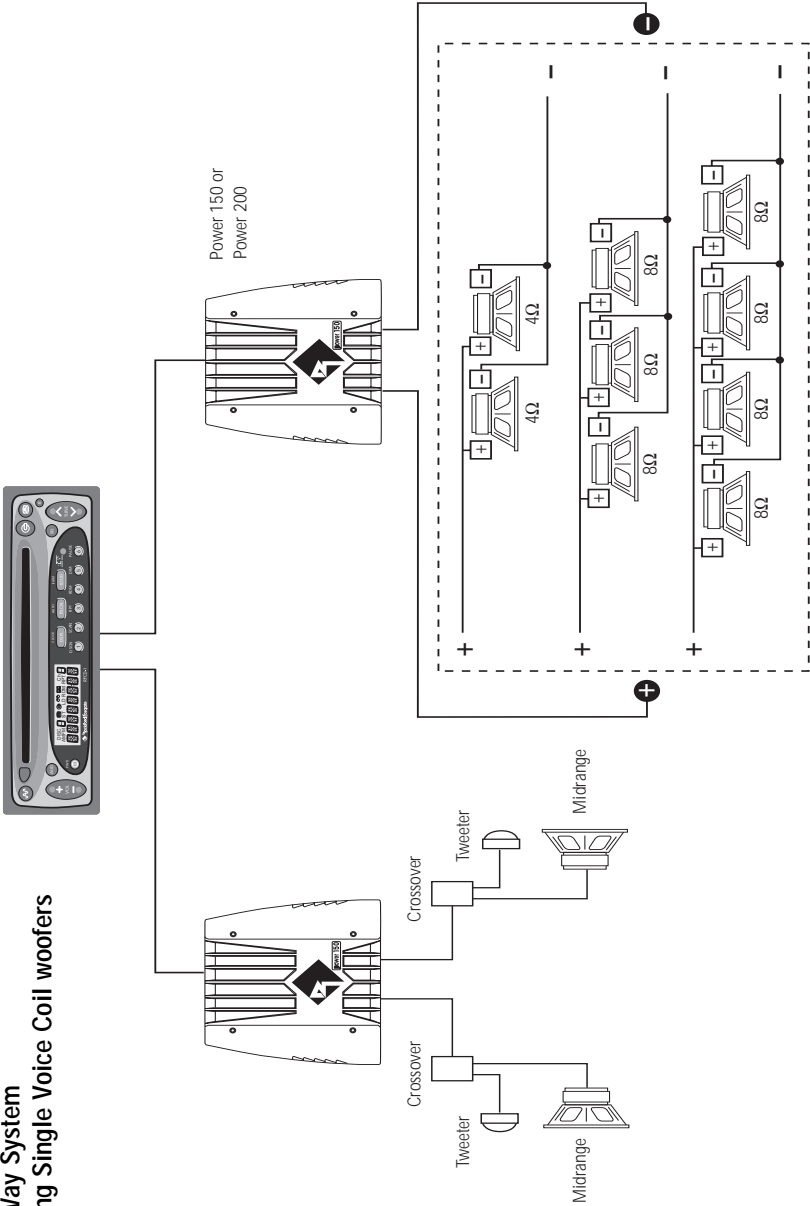

3-Way System using Dual Voice Coil woofers

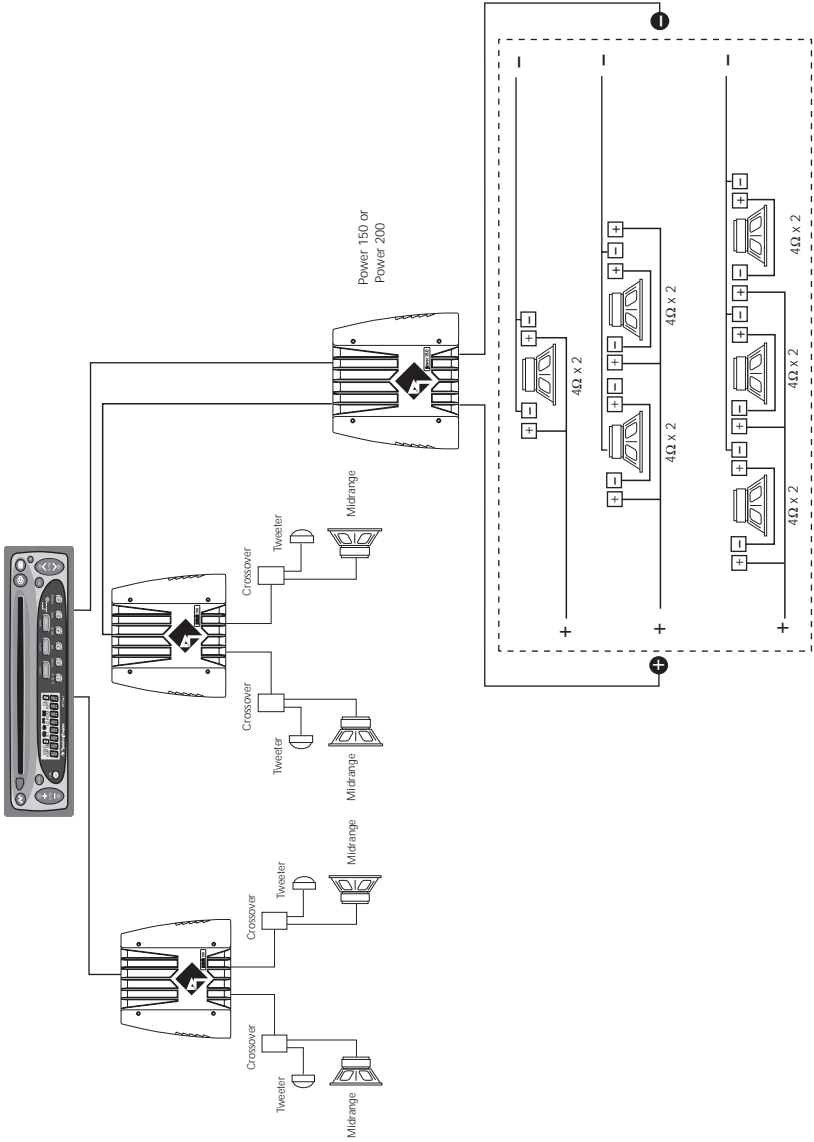

High Powered 3-Way System

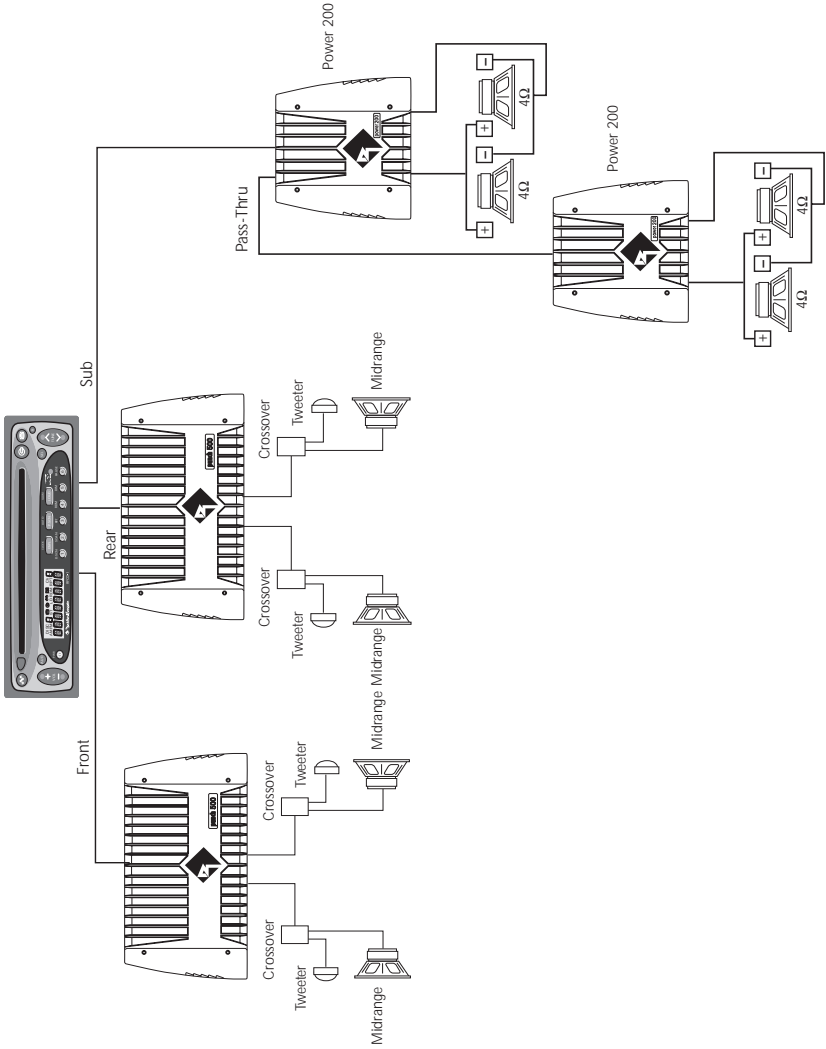



Symptom	Diagnosis	Remedy
Amplifier does not turn on (Power LED is off)	Voltage applied to the REM terminal of the amplifier is not between 10.5 and 15.5 volts or there is no voltage present.	Check the alternator, battery, fuse, and wiring and repair as necessary. If the voltage is above 15.5 volts, have the electrical system inspected by an authorized car service center.
	Voltage to the B+ terminal of the amplifier is not between 10.5 and 15.5 volts or there is no voltage present.	Check the alternator, battery, fuse, and wiring and repair as necessary. If the voltage is above 15.5 volts, have the electrical system inspected by an authorized car service center.
	Amplifier is not properly grounded.	Check wiring and repair as necessary.
Amplifier has no sound (Power LED is on)	Speaker leads are shorted to each other or to the chassis of the vehicle.	Disconnect existing speakers and test with known working speakers and wires. If amplifier plays, check and repair wiring and installation of speakers as necessary.
	Speakers are defective.	Disconnect existing speakers and test with known working speakers. If amplifier plays, check and repair speakers as necessary.
Speaker Output Low or Distorted	Input gain signal for amplifier is incorrectly set.	Readjust input gains of amplifier.
	Source unit output too low or source unit has no output.	Check system with known working source and repair or replace original source as needed.
	Low battery voltage or large voltage drops to the amplifier under load.	Check the alternator, battery, fuse, and power and ground wiring. Repair as necessary.
Amplifier Noise (Turn-on Pop)	Voltage spike from output of preceding component is entering amplifier through input signal.	Disconnect input signal to amplifier and turn amplifier on and off. If noise is eliminated, connect REM lead of amplifier to source unit with a delay turn-on module.



Symptom	Diagnosis	Remedy
Amplifier Noise (Turn-on Pop)	Voltage spike from remote turn-on lead is entering through REM input terminal.	Use a different 12 volt source for REM lead of amplifier (i.e., battery direct). If noise is eliminated, use a relay to isolate amplifier from noisy turn-on output.
Engine Noise	Noise is radiating into RCA signal cable.	Check connections, run the RCA cables on a different route away from sources of high current.
	Bad component in the signal chain.	Check connections, bypass additional components (crossovers and equalizers) between the source unit and the amplifier. Connect one component at a time to determine the culprit. Repair or replace components as necessary.
	Noise is radiating into speaker cables.	Disconnect existing speakers and connect a test speaker to the output terminals of the amplifier. If noise is gone, reroute the speaker cables away from sources of high voltage.
	Multiple grounds in the audio system.	Check ground connections and connect amplifiers, signal processors, and other components to a central location or try a different grounding point on the chassis.
	Ground loop between source unit and antenna.	Check connections, disconnect antenna from source unit. If noise is gone, install an antenna ground loop isolator.
Engine Noise when using high level inputs	TOPAZ input circuitry (in Rockford amps) or floating input circuitry (in non-Rockford amps) does not have reference to "chassis ground." This noise, if any, occurs at the auxiliary amplifier whose inputs are fed from the pass-thru output of the first amp.	Supply reference ground to the TOPAZ input circuit (or floating input circuit in non-Rockford amps). Connect shield of RCA input from auxiliary amp to chassis ground of radio. An alternative method is to connect the RCA shield to the amplifier's power ground terminal.

• If noise persists, see your Authorized Rockford Fosgate Dealer.

DYNAMIC POWER MEASUREMENTS

About the Dynamic Power Measurements

The Audio Graph PowerCube is a test instrument used to measure the output of an amplifier in accordance with IHF-202 industry standards. The IHF-202 standard is a dynamic power measurement and was developed as a means of measuring power in a manner that best represents the Real World operation of an amplifier. Many manufacturers, including Rockford Fosgate, at times will measure amplifier power into a fixed resistor (4 ohm, 2 ohm). While this method is useful in some types of evaluation and testing, it is not representative of an amplifier that is connected to a speaker and playing music.

Music

Music is dynamic; the sound waves are complex and constantly changing. In order to simulate this, the IHF-202 standard calls for the input signal to the amplifier to be a 1kHz bursted tone. This signal is input (on for 20 milliseconds) and reduced 20dB for 480 milliseconds. The signal is gradually increased in level until the amplifier's output exceeds 1% Total Harmonic Distortion (THD). At 1%, distortion becomes audible, therefore, any power produced above that level is considered *unusable*. Many manufacturers represent their amplifiers' output power in excess of 10% distortion. They use many names for this measurement, such as Total Maximum Power or Maximum Output Power. This is not indicative of the *actual usable output power*.

Listening to Loudspeakers - Not Resistors

A loudspeaker is not a resistor. A resistor's value (resistance measured in ohms) is fixed. A loudspeaker's impedance is dynamic. It is constantly changing in value, dependent upon the frequency of the input signal. Therefore, measuring power with the amplifier loaded into a 4 ohm resistor is not the same as measuring power with the amplifier connected to a 4 ohm speaker. Most people do not listen to music through a resistor.

A 4 ohm speaker may experience a drop in impedance 4-6 times lower than its nominal (printed) impedance. A speaker will also create phase shifts in the signal that is passed through it. These phase shifts happen because a speaker is an inductor (voice coil) and a capacitor (compliance of the surround/spider), as well as a resistor (voice coil wire).

To simulate a speaker the Audio Graph PowerCube measures output power into 20 different loads. It tests at 8 ohms, 4 ohms, 2 ohms and 1 ohm. Each of these impedances is also tested at -60° , -30° , 0° , $+30^\circ$ and $+60^\circ$ phase angles. These different impedances and phase angles represent the shifts in impedance and phase that can occur in a typical loudspeaker.

Information Cubed

The data acquired in the testing procedure is then graphed in the form of a 3-dimensional cube, hence the name **PowerCube**.

The *Phase Angle* is expressed on the horizontal axis, the *Output Voltage* is presented on the vertical axis and the *Impedance* is displayed on the Z axis. *Output Power*, in watts, is listed on the left hand side for each impedance at each phase angle.

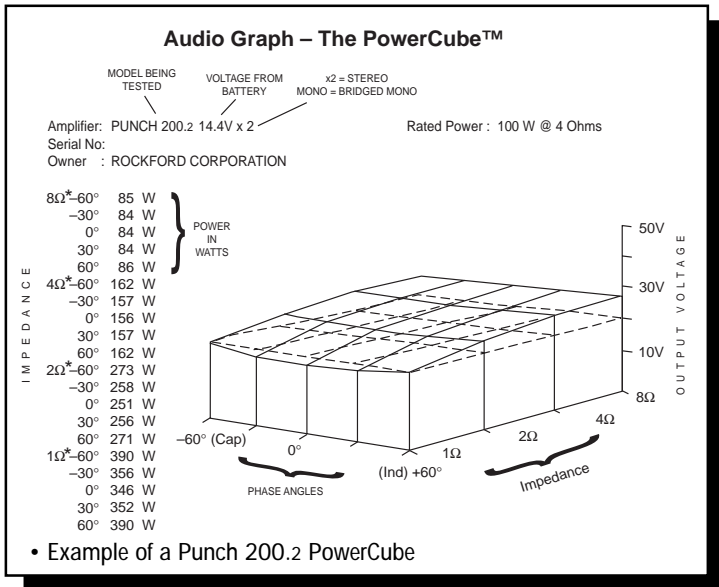

What is an Amplifier?

An amplifier by definition is a voltage generating device, recreating the signal which is input to it identically but with increased volume. It will be connected to a reactive load (the speaker). The impedance of this load and phase of the signal passing through the load will vary, dependent upon the frequency of the input signal (music).

Therefore, a perfect amplifier will be able to maintain the same output voltage regardless of load characteristics and will not alter the signal it is reproducing. A perfect amplifier when measured by the Audio Graph PowerCube would present data that forms a perfect cube. Unfortunately, amplifiers are not perfect. The laws of physics generally prevent it. A great amplifier is about the best one can hope to attain.

As you can see by the PowerCube and as you will experience by listening, your Punch amplifier is a **GREAT AMPLIFIER!**

LIMITED WARRANTY INFORMATION

Rockford Corporation offers a limited warranty on Rockford Fosgate products on the following terms:

- **Length of Warranty**

3 years on electronics	90 days on electronic B-stock (receipt required)
2 years on source units	
1 year on speakers	90 days on speaker B-stock (receipt required)

- **What is Covered**

This warranty applies only to Rockford Fosgate products sold to consumers by Authorized Rockford Fosgate Dealers in the United States of America or its possessions. Product purchased by consumers from an Authorized Rockford Fosgate Dealer in another country are covered only by that country's Distributor and not by Rockford Corporation.

- **Who is Covered**

This warranty covers only the original purchaser of Rockford product purchased from an Authorized Rockford Fosgate Dealer in the United States. In order to receive service, the purchaser must provide Rockford with a copy of the receipt stating the customer name, dealer name, product purchased and date of purchase.

- **Products found to be defective** during the warranty period will be repaired or replaced (with a product deemed to be equivalent) at Rockford's discretion.

- **What is Not Covered**
 1. Damage caused by accident, abuse, improper operations, water, theft
 2. Any cost or expense related to the removal or reinstallation of product
 3. Service performed by anyone other than Rockford or an Authorized Rockford Fosgate Service Center
 4. Any product which has had the serial number defaced, altered, or removed
 5. Subsequent damage to other components
 6. Any product purchased outside the U.S.
 7. Any product not purchased from an Authorized Rockford Fosgate Dealer

- **Limit on Implied Warranties**

Any implied warranties including warranties of fitness for use and merchantability are limited in duration to the period of the express warranty set forth above. Some states do not allow limitations on the length of an implied warranty, so this limitation may not apply. No person is authorized to assume for Rockford Fosgate any other liability in connection with the sale of the product.

- **How to Obtain Service**

Please call 1-800-669-9899 for Rockford Customer Service. You must obtain an RA# (Return Authorization number) to return any product to Rockford Fosgate. You are responsible for shipment of product to Rockford.

Ship to: **Electronics**
Rockford Corporation
Warranty Repair Department
2055 E. 5th Street
Tempe, AZ 85281
RA#: _____

Ship to: **Speakers**
Rockford Acoustic Design
(Receiving-speakers)
609 Myrtle N.W.
Grand Rapids, MI 49504
RA#: _____



LEA DETENIDAMENTE LAS SIGUIENTES INSTRUCCIONES DE INSTALACION DEL PRODUCTO. EVITARA POSIBLES DAÑOS A VD., AL VEHICULO O AL PRODUCTO.

INTRODUCCION

Los ingenieros de Rockford han diseñado los amplificadores Power para ofrecer en el difícil entorno de un automóvil una calidad de sonido superior en un producto flexible, fiable y eficiente. Trans•ana es un circuito de baja tensión en la etapa de preamplificación de los amplificadores Power que permite que la musica suene limpia y cristalina y muy real, incluso a altos niveles de audicion. Esto se complementa con el TOPAZ, un circuito exclusivo de masa utilizado para eliminar los ruidos asociados con las instalaciones de car-audio. La flexibilidad esta garantizada con el uso de la XCard incorporada. La fiabilidad se refuerza con el uso de un circuito de proteccion llamado NOMAD, mientras que los MOSFET y la tecnologia DSM (montaje discreto en superficie) aumentan la eficiencia del amplificador. La combinacion de todos estos componentes dan al amplificador Power una impresionante calidad de sonido en un chasis discreto. Mas adelante encontrará mas explicaciones de todas estas tecnologias, la mayoría de ellas usados en exclusiva y patentadas por Rockford.

UBICACIÓN PARA EL MONTAJE

Montaje en el Malatero

Monte el amplificador verticalmente con las líneas del radiador orientadas de arriba hacia abajo. De esta manera conseguira la mejor ventilacion.

Montaje en el Compartimento de Pasajeros

El montaje en el compartimento de pasajeros sera eficiente en funcion de la ventilacion que tenga el amplificador. Si va a instalar el amplificador bajo un asiento deberá dejar al menos 2.5cm libres sobre la carcasa del amplificador.

Instalacion

Por seguridad, desconecte el terminal negativo de la bateria antes de comenzar la instalacion.

Terminal B+

El cable B+ debe ir provisto de un fusible a una distancia no mayor de 45cm de la bateria. Prepare el cable e instale el portafusibles en el compartimento del motor. Las conexiones han de ser impermeables.

Terminal GND

Prepare un trozo de cable para usarlo como toma de masa. Prepare un punto de masa en el chasis rascando y eliminando la pintura de la superficie de metal y límpielo de toda suciedad asegure el cable al chasis con un tornillo.

Terminal REM

Conecte el cable REM a un punto de +12V conmutable. La señal se suele coger de la salida auto antenna del radio cassette si este no tiene salida remote.

Funcionamiento Mono

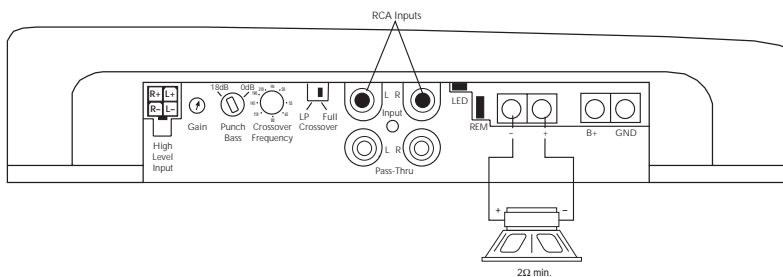

- Las entradas **RCA** se conectan a ambos *canales izquierdo y derecho*
- La **impedancia** mínima mono debe ser 2Ω .
- Los **Divisores de Frecuencia Variable** pueden ser ajustados para Rango Completo (FULL) ó Pasa-Bajos (LP) entre 50 Hz y 210Hz.

ATTENTION: Veuillez lire les instructions suivantes pour l'installation de cet amplificateur. Ne pas les suivre pourrait causer des blessures ou endommager le véhicule.

INTRODUCTION

Les ingénieurs de Rockford Fosgate ont conçu l'amplificateur Power pour supporter l'environnement rude de l'automobile en délivrant une qualité de son supérieure dans un ensemble efficace, fiable et flexible. Trans•ana est un circuit de bas voltage dans l'étage de préamplification de tous les amplificateurs Power qui reproduit un son musical clair comme du cristal et très réel, même à très haut volume. Ceci est accompagné du TOPAZ, un circuit unique employé pour éliminer les problèmes de bruits parasites associés aux systèmes audiomobile et leur installation. La flexibilité est assurée par l'emploi d'une XCard incorporée.

La fiabilité est garantie grâce au circuit de protection NOMAD, la technologie MOSFET et DSM (Composants Montés en Surface) améliorent l'efficacité de l'amplificateur.

L'ensemble de ces atouts donne à l'amplificateur Power une qualité de son inégalable sous une carrosserie "pare-balles."

Vous trouverez de plus amples informations sur ces technologies, exclusivement conçues et brevetées par Rockford, dans la rubrique technique.

MONTAGE

Montage dans le coffre

Monter l'amplificateur verticalement avec les rainures de haut en bas ce qui lui permet de refroidir plus facilement.

Montage dans l'habitacle

Monter l'amplificateur dans l'habitacle ne pose aucun problème, du moment qu'il y ait assez d'air pour le refroidir. Si vous montez l'ampli en dessous du siège, prévoyez 3 cm d'air autour du radiateur.

Installation

Pour votre sécurité, déconnectez la borne négative de la batterie du véhicule avant de commencer l'installation.

Terminal B+

Il est impératif qu'il y ait un fusible sur le câble pour la connexion à la masse. Préparez le châssis en grattant la peinture de la surface métallique et nettoyez la saleté et l'huile. Attachez le câble au châssis avec une vis.

Terminal GND

Préparez une longueur de câble pour la connexion à la masse. Préparez le châssis en grattant la peinture de la surface métallique et nettoyez la saleté et l'huile. Attachez le câble au châssis avec une vis.

Terminal REM

Connectez le fil REM à une commande 12 volts positive de la source. La commande 12 volts est habituellement prise sur la sortie antenne électrique de la source ou la commande accessoire. Si la source ne dispose pas de ces sorties, nous vous recommandons d'installer un interrupteur qui fournira un positif 12 volts au REM de l'amplificateur.

Opération mono

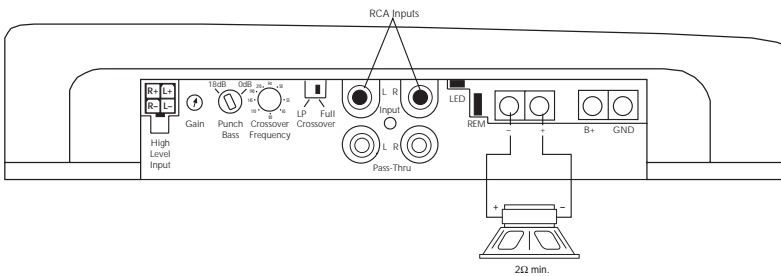

- Les entrées **RCA** sont connectées aux canaux gauche et droit
- L'**impédance** du canal mono devrait être de minimum 2Ω
- **Filtre actif**, position (full) sans action, ou passe-bas (LP) régleable entre 50Hz et 210Hz.

BITTE LESEN SIE DIESE GEBRAUCHSANLEITUNG ZUERST SORGFÄLTIG DURCH. DAS KANN SIE VOR DEM FALSCHEN EINSATZ, AUSFALLEN ODER SOGAR BESCHÄDIGUNG DES PRODUKTES ODER IHRES FAHRZEUGES SCHÜTZEN.

EINLEITUNG

Rockford Ingenieure haben die Power Verstärker entwickelt. Mit höchstem Technologie-Standart, hervorragender Klangqualität, einfacher Handhabung und bester Servicefreundlichkeit Trans•ana ist eine Nieder-Volt Schaltung im Vorverstärkerteil aller Power Verstärker die für kristallklaren Klang auch bei sehr hohen Lautstärken sorgt. TOPAZ, eine einzigartige Erdungsschaltung verhindert und unterdrückt Einstreuungen und Störungen die nur allzu oft Car Audio Systeme beeinträchtigen. Flexibilität durch die Vielfalt der Aktivweiche mit ihren XCards, lange Lebensdauer durch die Schutzschaltung NOMAD und der Einsatz von MOSFET Transistoren und DSM (Discrete Surface Mount), machen diese Verstärker so effizient. Das Ergebnis all dieser Komponenten machen Power-Verstärker so einzigartig und in ihrer Klangqualität nahezu unschlagbar. Eine genauere Beschreibung dieser Technologien, die größtenteils einzigartig und von Rockford patentiert sind, finden Sie unter Technical Design Features.

EINBAUORT

Im Fahrzeuggofferraum

Der vertikale Einbau der Endstufen, das bedeutet, daß die Kühlrippen von oben nach unten verlaufen, gibt dem Verstärker die beste Kühlung.

Auf der Beifahrerseite

Sollte der Verstärker auf der Beifahrerseite montiert werden, so ist es sehr wichtig, für eine ausreichende Kühlung zu sorgen. Sollte der Verstärker z.B. unter dem Beifahrersitz montiert werden, sollte dem Kühlkörper mindestens ein Luftspalt von 3 cm bleiben, um so für eine ausreichende Kühlung zu sorgen.

Einbau

Zur Sicherheit klemmen Sie den Negativ-Pol der Batterie während des gesamten Einbaues ab.

B+ Anschluß

Die Plus-Leitung MUß ca. 40 cm nach dem Plus-Pol der Batterie abgesichert sein. Preparieren Si die Kabellängen und montieren Sie den Sicherungshalter im Motorraum. ALLE Verbindungen müssen wasserdicht sein.

GND Anschluß

Preparieren Sie Ihr Kabel für die Negativ Leitung (Erdung). Preparieren Sie die Anschlußstelle des Erdungskabels, indem Sie das Metall gründlich reinigen und vom Lack befreien. Befestigen Sie nun die Erdung an dieser Stelle mit einer Schraube.

REM Anschluß

Verbinden Sie das Ein- und Ausschaltungskontroll-Kabel mit Ihrem Radio (12 Volt positiv). Normalerweise verwenden Sie hierfür die Ant.-Remote Ihres Radios oder ein eigens dafür vorgesehenes Kabel (Amp-Remote). Sollte Ihr Radio diesen Anschluß nicht besitzen, so verwenden Sie eine 12 Volt Spannung, die Sie durch einen Schalter ein- und ausschalten können.

Mono Operation

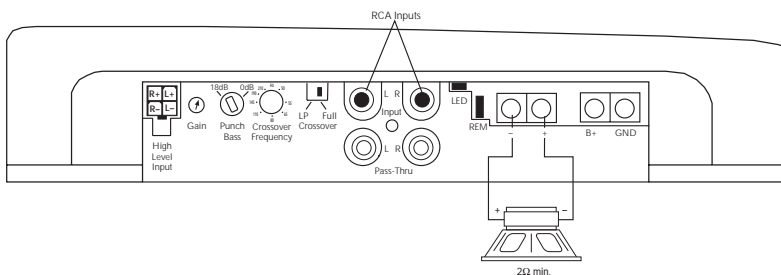

- Chinch Eingänge des *rechten- und linken-Kanals* anschließen
- Die **Impedanz** des Mono Kanals sollte *minimum 2 Ohm* betragen
- Die **variable Weiche** kann den vollen Frequenzbereich übertragen (Full) oder auf Tiefpass (LP) eingestellt werden, regelbar zwischen 50Hz und 210Hz.

ATTENZIONE: SI PREGA DI LEGGERE LE SEGUENTI ISTRUZIONI PER L'INSTALLAZIONE DI QUESTO PRODOTTO. IL NON SEGUIRLE POTREBBE RISULTARE SERIAMENTE DANNOSO PER LA PERSONA O PER IL VEICOLO.

INTRODUZIONE

Gli ingegneri Rockford hanno progettato la serie di amplificatori Power per resistere all'ostico ambiente automobilistico mentre suonano con una musicalità superiore, offrendo un insieme versatile, affidabile ed efficiente. Trans•ana è un circuito a bassa tensione dello stadio preamplificatore del Power che permette al suono di essere cristallino e reale anche in presenza di volumi molto elevati...tutto questo è accoppiato TOPAZ, un esclusivo circuito di massa impiegato per eliminare i problemi di rumore comunemente presenti negli impianti car audio. Il massimo della versatilità è raggiunto con l'impiego delle XCard. L'affidabilità è completamente garantita dall'impiego di un circuito di protezione chiamato NOMAD, mentre l'uso di MOSFET e della tecnologia DSM (Discrete Surface Mount) permette di raggiungere efficienze elevatissime. Il risultato finale di tutte queste tecnologie moderne è che gli amplificatori Power suonano meravigliosamente e sono indistruttibili, a "prova di proiettile." Una spiegazione di queste tecnologie innovative, molte coperte da brevetti Rockford, sono descritte in un'altra sezione di questo manuale.

DOVE POSIZIONARLO

Nel Bagagliaio

Montando l'amplificatore su una superficie in verticale con le alette direzionate dall'alto verso il basso si garantirà un miglior raffreddamento dell'amplificatore.

Nell'abitacolo

Montare l'amplificatore nell'abitacolo si avrà un funzionamento regolare se si garantisce un flusso d'aria sufficiente. Per l'installazione sotto un sedile, è necessario avere uno spazio di almeno 3 cm attorno a tutto l'amplificatore.

Installazione

Per sicurezza, scollegare il polo negativo della batteria dell'auto prima di iniziare l'installazione.

Terminale B+ (cavo positivo)

Il cavo positivo deve essere protetto da un fusibile a non più di 45 cm dalla batteria. Terminare il cavo e installare il fusibile nel vano motore. Tutte le connessioni devono essere a prova d'acqua.

Terminale GND (cavo negativo)

Decidere la lunghezza del cavo e terminarlo. Preparare la massa grattando la vernice dal telaio dell'auto ed eliminando tracce di olio o sporco. Fissare il cavo di massa al telaio con una vite.

Terminale REM (Consenso di accensione)

Collegare il cavo REM ad un positivo presente solo ad autoradio accesa (normalmente il cavo pilota dell'antenna elettrica o il cavo accessori dell'autoradio). Se la sorgente non dovesse essere equipaggiata con queste uscite, la soluzione raccomandabile é di inserire un interruttore su un cavo positivo e connettersi all'amplificatore.

Mono Operation

The diagram shows a car stereo amplifier control panel. On the left, there is a 'High Level Input' section with 'R+' and 'L+' terminals. Next to it is a 'Gain' knob. To the right are 'Punch Bass' and 'Crossover Frequency' knobs. Further right are 'LP' and 'Full' crossover switches. In the center, there are 'RCA Inputs' labeled 'L' and 'R', and 'Pass-Thru' inputs labeled 'L' and 'R'. To the right of the RCA inputs is an 'LED' indicator. Further right are 'REM', 'B+', and 'GND' terminals. A speaker is connected to the 'B+' and 'GND' terminals, with a note '2Ω min.' below it.

- Ingressi **RCA** collegati sia al canale destro sia al sinistro
- L'**impedenza** per il canale mono deve essere minimo 2Ω
- Il **crossover regolabile** può essere impiegato a gamma intera, Full Range, (FULL) o come passa-basso (LP) regolabile da 50Hz a 210Hz.

Get maximum performance by
surfing for the ultimate
Punch system designs at:
www.rockfordfosgate.com

HANDCRAFTED IN THE UNITED STATES OF AMERICA

This product is designed, developed and assembled in the USA by a dedicated group of American workers. The majority of the components used in the construction of this product are produced by American companies. However, due to the global nature of their manufacturing facilities and the loudspeaker parts industry in general, some parts may be manufactured in other countries.



Rockford Corporation
546 South Rockford Drive
Tempe, Arizona 85281 U.S.A.
In U.S.A., (602) 967-3565
In Europe, Fax (49) 8503-934014
In Japan, Fax (81) 559-79-1265